



(19) **United States**

(12) **Patent Application Publication**
Sakamoto

(10) **Pub. No.: US 2016/0315267 A1**

(43) **Pub. Date: Oct. 27, 2016**

(54) **MATERIAL FOR ORGANIC ELECTROLUMINESCENT DEVICE, ORGANIC ELECTROLUMINESCENT DEVICE INCLUDING THE SAME AND PREPARATION METHOD OF TRIARYLAMINE DERIVATIVES**

H01L 51/0073 (2013.01); *H01L 51/0052* (2013.01); *H01L 51/0074* (2013.01); *H01L 51/0056* (2013.01)

(57) **ABSTRACT**

Provided are a material for an organic electroluminescent device having a high emission efficiency and an organic electroluminescent device including the same. The material for an organic electroluminescent device according to the present disclosure is represented by Formula 1:

(71) Applicant: **SAMSUNG DISPLAY CO., LTD.**,
Yongin-si (KR)

(72) Inventor: **Naoya Sakamoto**, Yokohama (JP)

(21) Appl. No.: **15/048,505**

Formula 1

(22) Filed: **Feb. 19, 2016**

(30) **Foreign Application Priority Data**

Apr. 21, 2015 (JP) 2015-086493

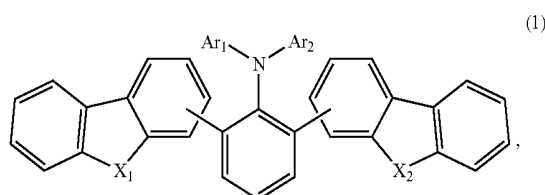

Publication Classification

(51) **Int. Cl.**
H01L 51/00 (2006.01)
C07D 333/76 (2006.01)
C07D 409/10 (2006.01)
C07D 307/91 (2006.01)

in which dibenzoheterole groups are coupled to a phenyl group of a triarylamine at the ortho positions relative to the nitrogen atom. The polarity of the molecule may be increased due to the heteroatoms of the dibenzoheterole groups, and the energy gap (e.g., HOMO-LUMO gap) of the molecule may be increased due to the large steric distortion of the molecule around the amine group. Accordingly, the emission efficiency of an organic EL device may be improved in the blue emission region.

(52) **U.S. Cl.**
CPC *H01L 51/0061* (2013.01); *H01L 51/006* (2013.01); *C07D 307/91* (2013.01); *C07D 333/76* (2013.01); *C07D 409/10* (2013.01);

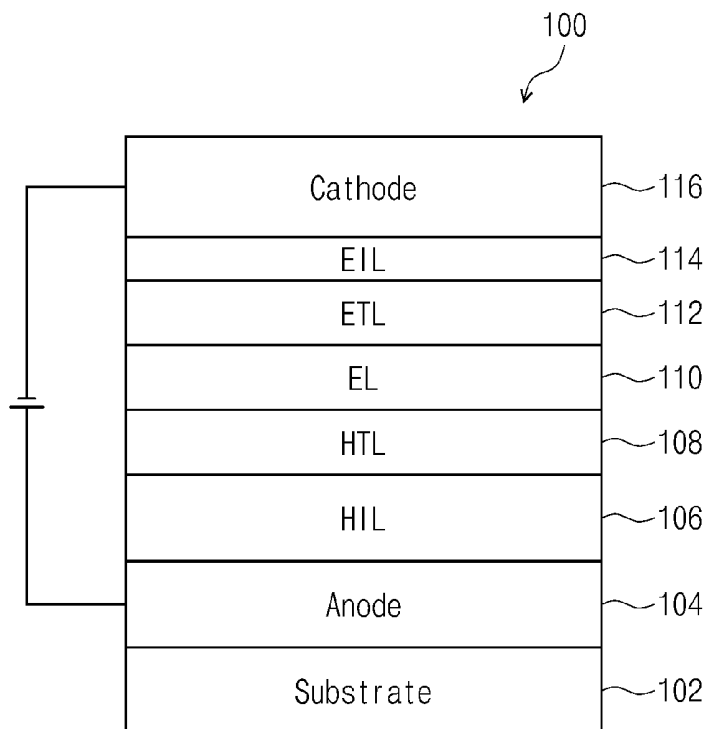

FIG. 1

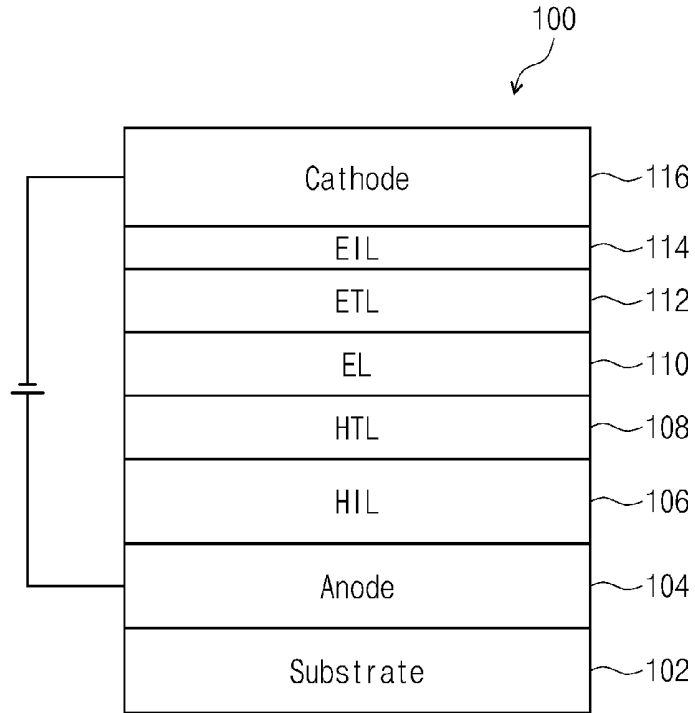
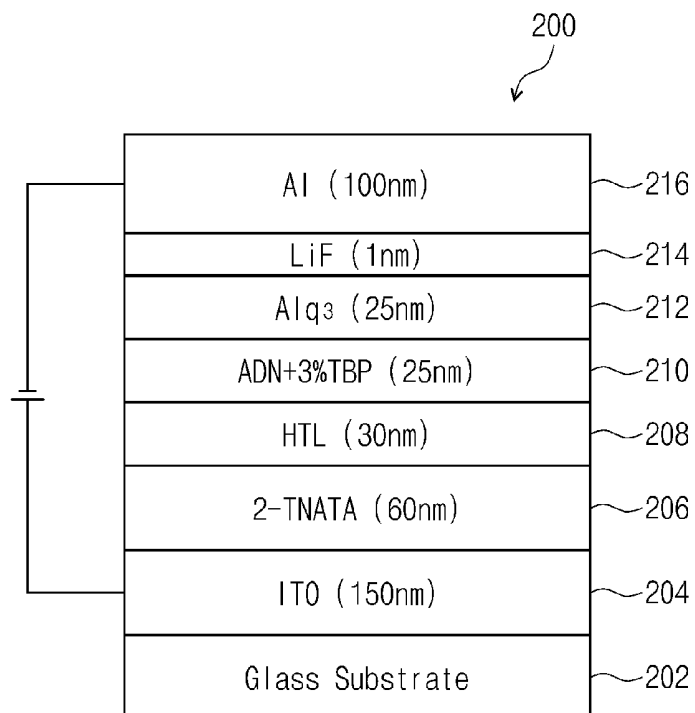

FIG. 2



**MATERIAL FOR ORGANIC
ELECTROLUMINESCENT DEVICE,
ORGANIC ELECTROLUMINESCENT
DEVICE INCLUDING THE SAME AND
PREPARATION METHOD OF
TRIARYLAMINE DERIVATIVES**

CROSS-REFERENCE TO RELATED
APPLICATION

[0001] This U.S. patent application claims priority to and the benefit of Japanese Patent Application No. 2015-086493, filed on Apr. 21, 2015, in the Japan Patent Office, the entire content of which is incorporated herein by reference.

BACKGROUND

[0002] 1. Field

[0003] One or more aspects of embodiments of the present disclosure relate to a material for an organic electroluminescent device, an organic electroluminescent device using the same, a method of preparing triarylamine derivatives, a hole transport material for an organic electroluminescent device having high emission efficiency and long life, an organic electroluminescent device using the same, and/or a preparation method of the material for an organic electroluminescent device.

[0004] 2. Description of the Related Art

[0005] Organic electroluminescent (EL) displays are currently being actively developed. Unlike liquid crystal displays, etc., organic EL displays are so-called self-luminescent displays that function by recombining holes and electrons from an anode and a cathode in an emission layer to generate excitons for emitting light energy. Light is emitted from a luminescent organic compound in the emission layer.

[0006] An example organic EL device includes an anode, a hole transport layer on the anode, an emission layer on the hole transport layer, an electron transport layer on the emission layer, and a cathode on the electron transport layer. Holes injected from the anode move via the hole transport layer to the emission layer. Electrons injected from the cathode move via the electron transport layer to the emission layer. When the holes and electrons injected into the emission layer are recombined, excitons are generated in the emission layer. The organic EL device emits light using energy generated by the radiative decay of the excitons. Configurations of the organic EL device are not limited to the above example, and may be diversely modified.

[0007] When organic EL devices are used in display apparatuses, the organic EL devices should exhibit high emission efficiencies and long lifetimes. However, driving voltages are high and emission efficiencies are insufficient in many organic EL devices, for example, those in the blue emission region. Methods of increasing the normalization, stabilization, and durability of the hole transport layer have been examined as strategies for increasing the efficiencies and lifetimes of organic EL devices.

[0008] Many aromatic amine compounds are available as hole transport materials for use in a hole transport layer. For example, an amine derivative substituted with a heteroaryl ring has been suggested as a useful material for increasing the emission efficiency of an organic EL device in the blue emission region. However, issues related to resolving the emission efficiency of the device remain, and it is difficult to

say that an organic EL device using the material has a sufficient emission efficiency. For example, the emission efficiencies of organic EL devices are low in the blue emission region relative to the red and green emission regions, and an increase of emission efficiency in the blue emission region is desirable. An aniline derivative having aryl groups at positions 2 and 6 has been suggested as a material for increasing the emission efficiency of an organic EL device; however, a device using the material was not considered to have sufficient emission efficiency. An aniline derivative having substituents at positions 2 and 6 has been disclosed as a luminescent material but was considered to be inappropriate or unsuitable as a hole transport material, because the amine site is a ring shape (e.g., contained within a cyclic moiety) and the compound includes an electron withdrawing group. Accordingly, further developments on material for an organic EL device having an even higher efficiency are needed.

SUMMARY

[0009] One or more aspects of embodiments of the present disclosure are directed toward a material for an organic EL device having a high emission efficiency, an organic EL device including the same, and a method of preparing the material for an organic EL device.

[0010] One or more embodiments of the present disclosure also provide a material for an organic EL device having a high emission efficiency in the blue emission region, an organic EL device including the same in at least one laminated layer, and a method of preparing the material for an organic EL device.

[0011] An embodiment of the present disclosure provides a material for an organic EL device represented by the following Formula 1:

Formula 1

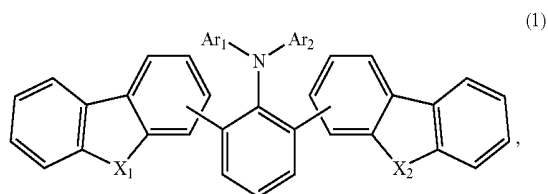

[0012] In Formula 1, Ar₁ and Ar₂ may each independently be selected from a substituted or unsubstituted aryl group having 6 to 30 carbon atoms for forming a ring, and a substituted or unsubstituted heteroaryl group having 1 to 30 carbon atoms for forming a ring. X₁ and X₂ may each independently be selected from O, S, R₁—Si—R₂ and N—R₃, and R₁ to R₃ may each independently be selected from an alkyl group having 1 to 10 carbon atoms, and an aryl group having 6 to 30 carbon atoms for forming a ring.

[0013] The material for an organic EL device according to an embodiment of the present disclosure may include an aniline derivative having a structure in which dibenzoheterole groups are introduced (e.g., coupled) to a phenyl group of a triarylamine at the ortho positions relative to the nitrogen atom. The polarity of the molecule may be increased due to the heteroatoms of the dibenzoheterole groups, and the energy gap (e.g., HOMO-LUMO gap) of the molecule may be increased due to the large steric distortion

of the molecule around the amine group. Accordingly, the emission efficiency of an organic EL device may be improved in the blue emission region.

[0014] In Formula 1, X_1 and X_2 may each independently be selected from O and S.

[0015] In an embodiment of the present disclosure, Ar_1 and Ar_2 in Formula 1 may each independently be selected from a naphthyl group, a biphenyl group, a terphenyl group, a naphthylphenyl group, a dibenzofuryl group and a dibenzothiophenyl group.

[0016] In an embodiment of the present disclosure, an organic EL device includes an anode, an emission layer on the anode, and a laminated layer between the anode and the emission layer. At least one selected from the emission layer and the laminated layer may include a material for an organic EL device represented by Formula 1:

Formula 1

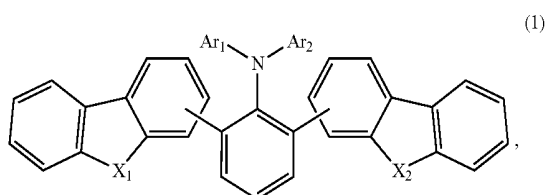

[0017] In Formula 1, Ar_1 and Ar_2 may each independently be selected from a substituted or unsubstituted aryl group having 6 to 30 carbon atoms for forming a ring and a substituted or unsubstituted heteroaryl group having 1 to 30 carbon atoms for forming a ring; X_1 and X_2 may each independently be selected from O, S, R_1-Si-R_2 and $N-R_3$, and R_1 to R_3 may each independently be selected from an alkyl group having 1 to 10 carbon atoms and an aryl group having 6 to 30 carbon atoms for forming a ring.

[0018] In an embodiment of the present disclosure, the laminated layer may include a hole transport layer, and the hole transport layer may include the material for an organic EL device.

[0019] The organic EL device according to an embodiment of the present disclosure may attain a high emission efficiency by including one of the materials for an organic EL device in at least one of the laminated layers between the emission layer and the anode (for example, as a material for a hole transport layer).

[0020] In an embodiment of the present disclosure, a method of preparing a triarylamine derivative represented by the following Formula 1 includes preparing an amine derivative by reacting a 1-amino-2,6-halogenated benzene with a dibenzoheterole derivative substituted with boronic acid, and reacting the resulting primary amine derivative with an unsubstituted aryl halide group having 6 to 30 carbon atoms for forming a ring or a substituted or unsubstituted heteroaryl halide group having 1 to 30 carbon atoms for forming a ring.

Formula 1

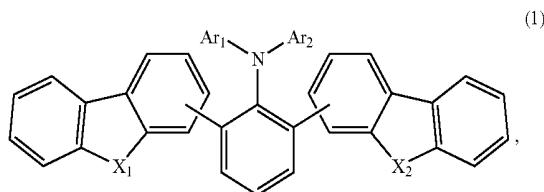

[0021] In Formula 1, Ar_1 and Ar_2 may each independently be selected from a substituted or unsubstituted aryl group having 6 to 30 carbon atoms for forming a ring, and a substituted or unsubstituted heteroaryl group having 1 to 30 carbon atoms for forming a ring; X_1 and X_2 may each independently be selected from O, S, R_1-Si-R_2 and $N-R_3$; and R_1 to R_3 may each independently be selected from an alkyl group having 1 to 10 carbon atoms, and an aryl group having 6 to 30 carbon atoms for forming a ring.

BRIEF DESCRIPTION OF THE DRAWINGS

[0022] The accompanying drawings are included to enable further understanding of the present disclosure, and are incorporated in and constitute a part of this specification. The drawings illustrate example embodiments of the present disclosure and, together with the description, serve to explain principles of the present disclosure. In the drawings:

[0023] FIG. 1 is a schematic diagram of an organic EL device 100 according to an embodiment of the present disclosure; and

[0024] FIG. 2 is a schematic diagram of an organic EL device 200 according to another embodiment of the present disclosure.

DETAILED DESCRIPTION

[0025] Hereinafter, the material for an organic EL device and the organic EL device including the same according to an embodiment of the present disclosure will be described with reference to the accompanying drawings. The material for an organic EL device and the organic EL device including the same may, however, be embodied in different forms and should not be construed as limited to the embodiments set forth herein. In the drawings, like reference numerals refer to like elements or elements having like functions throughout, and repeated explanations thereof will not be provided.

[0026] In the drawings, the thicknesses of layers, films, panels, regions, etc., may be exaggerated for clarity. It will be understood that when an element such as a layer, film, region, or substrate is referred to as being "on" another element, it can be directly on the other element or intervening element(s) may also be present. In contrast, when an element is referred to as being "directly on" another element, no intervening elements are present.

[0027] One or more embodiments of the present disclosure provide a material for an organic EL device including an amine compound, represented by the following Formula 1:

Formula 1

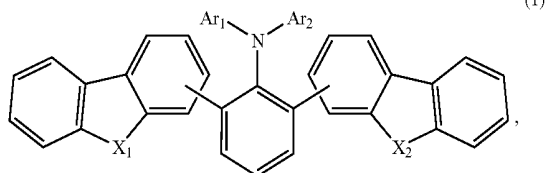

[0028] In Formula 1, Ar₁ and Ar₂ may each independently be selected from a substituted or unsubstituted aryl group having 6 to 30 carbon atoms for forming a ring and a substituted or unsubstituted heteroaryl group having 1 to 30 carbon atoms for forming a ring. X₁ and X₂ may each independently be selected from O, S, and N—R₃, and R₁ to R₃ may each independently be selected from an alkyl group having 1 to 10 carbon atoms and an aryl group having 6 to 30 carbon atoms for forming a ring. As used herein, “atoms for forming a ring” may refer to “ring-forming atoms”.

[0029] In Formula 1, non-limiting examples of the aryl group having 6 to 30 carbon atoms for forming a ring used as Ar₁ and Ar₂ may include a phenyl group, a naphthyl group, an anthracenyl group, a phenanthryl group, a biphenyl group, a terphenyl group, a quaterphenyl group, a fluorenyl group, a triphenylenyl group, a pyrenyl group, a benzofluoranthenyl group, a chrysenyl group, a phenylnaphthyl group, a naphthylphenyl group, etc. In some embodiments, the aryl group may have 10 to 18 carbon atoms for forming a ring and may be selected from a naphthyl group, a biphenyl group, a terphenyl group, and a naphthylphenyl group.

[0030] Non-limiting examples of the heteroaryl group having 1 to 30 carbon atoms for forming a ring used as Ar₁ and Ar₂ may include a benzothiazolyl group, a thiophenyl group, a thienothiophenyl group, a dithienothiophenyl group, a benzothiophenyl group, a benzofuryl group, a dibenzothiophenyl group, a dibenzofuryl group, an N-aryl-carbazolyl group, an N-heteroarylcarbazolyl group, an N-alkylcarbazolyl group, a phenoxazolyl group, a phenothiazyl group, a pyridyl group, a pyrimidyl group, a triazolyl group, a quinolinylyl group, a quinoxalyl group, etc. In some embodiments, Ar₁ and Ar₂ may be a heteroaryl group having 12 to 18 carbon atoms for forming a ring, and non-limiting examples may include the dibenzofuryl group and the dibenzothiophenyl group.

[0031] Ar₁ and Ar₂ may include one or more substituents selected from an alkyl group, an alkoxy group having 1 to 6 carbon atoms, and a phenyl group. Non-limiting examples of the alkyl group having 1 to 6 carbon atoms may include a methyl group, an ethyl group, an n-propyl group, an i-propyl group, an n-butyl group, an s-butyl group, a t-butyl group, an n-pentyl group, an n-hexyl group, a c-propyl group, a c-butyl group, a c-pentyl group, a c-hexyl group, etc. Non-limiting examples of the alkoxy group having 1 to 6 carbon atoms may include a methoxy group, an ethoxy group, an n-propoxy group, an i-propoxy group, an n-butoxy group, an s-butoxy group, a t-butoxy group, an n-pentoxy group, an n-hexoxy group, a c-propoxy group, a c-butoxy group, a c-pentoxy group, a c-hexoxy group, etc.

[0032] As described above, in Formula 1, X₁ and X₂ may each independently be selected from O, S, R₁—Si—R₂, and N—R₃, and R₁ to R₃ may each independently be selected

from an alkyl group having 1 to 10 carbon atoms and an aryl group having 6 to 30 carbon atoms for forming a ring. In some embodiments, X₁ and X₂ may each independently be selected from O and S.

[0033] Non-limiting examples of the alkyl group having 1 to 10 carbon atoms used as R₁ to R₃ may include a methyl group, an ethyl group, an n-propyl group, an i-propyl group, an n-butyl group, an s-butyl group, a t-butyl group, an n-pentyl group, an n-hexyl group, a c-propyl group, a c-butyl group, a c-pentyl group, a c-hexyl group, etc. Non-limiting examples of the alkoxy group having 1 to 6 carbon atoms may include a methoxy group, an ethoxy group, an n-propoxy group, an i-propoxy group, an n-butoxy group, an s-butoxy group, a t-butoxy group, an n-pentoxy group, an n-hexoxy group, a c-propoxy group, a c-butoxy group, a c-pentoxy group, a c-hexoxy group, etc.

[0034] Non-limiting examples of the aryl group having 6 to 30 carbon atoms for forming a ring used as R₁ to R₃ may include a phenyl group, a naphthyl group, an anthracenyl group, a phenanthryl group, a biphenyl group, a terphenyl group, a quaterphenyl group, a fluorenyl group, a triphenylenyl group, a pyrenyl group, a benzofluoranthenyl group, a chrysenyl group, a phenylnaphthyl group, a naphthylphenyl group, etc.

[0035] The material for an organic EL device according to an embodiment of the present disclosure may be an aniline derivative having a structure in which dibenzoheterole groups are introduced (e.g., coupled) to a phenyl group of a triarylamine at the ortho positions relative to the nitrogen atom. The polarity of the molecules may be increased due to the heteroatoms of the dibenzoheterole groups, and the energy gap (e.g., HOMO-LUMO gap) of the molecule may be increased due to the large steric distortion of the molecule near the amine. Accordingly, the emission efficiency of an organic EL device may be improved. When the material for an organic EL device according to an embodiment of the present disclosure is included in at least one laminated layer between the emission layer and the anode in an organic EL device (for example, as a material for a hole transport layer), the emission efficiency of the organic EL device may be improved in the blue emission region.

[0036] The material for an organic EL device according to an embodiment of the present disclosure may be one selected from the following Compounds (2) to (23), in which Compounds (2)-(19) are collectively referred to as Formula 2, and Compounds (20)-(23) are collectively referred to as Formula 3.

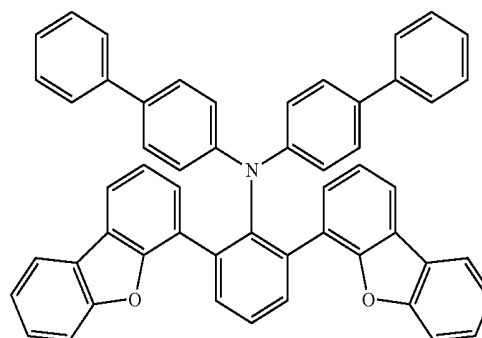

(2)

-continued

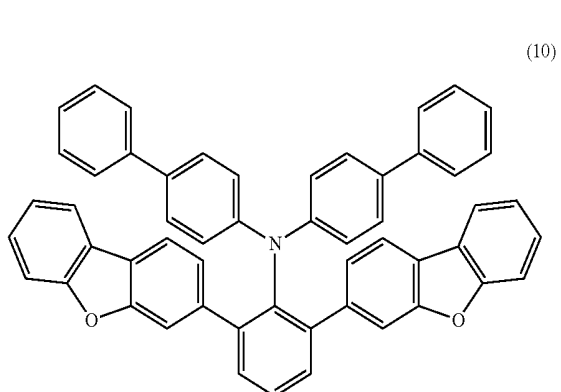
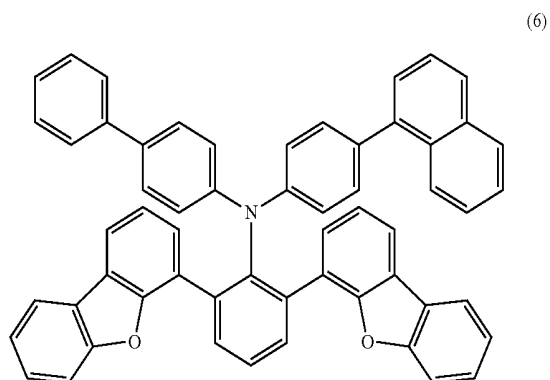
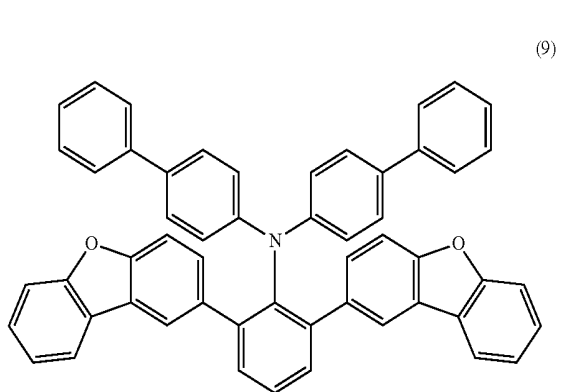
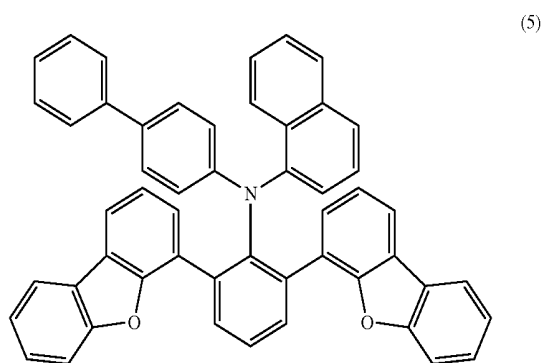
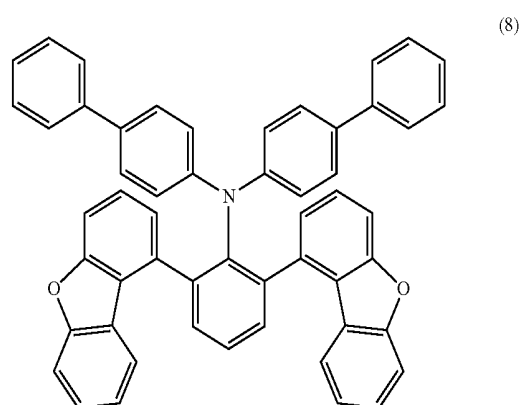
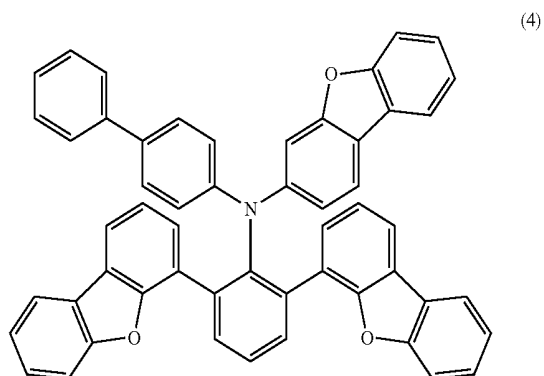
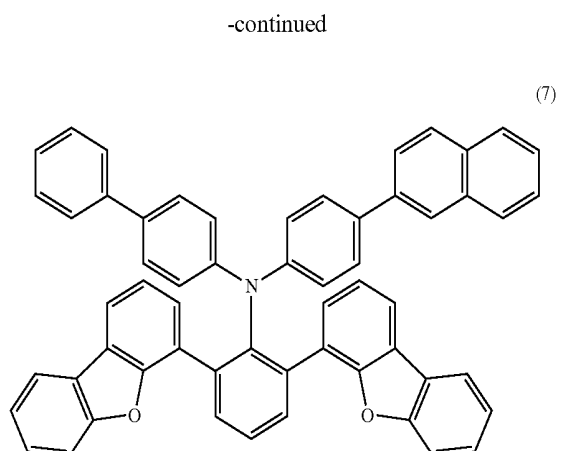
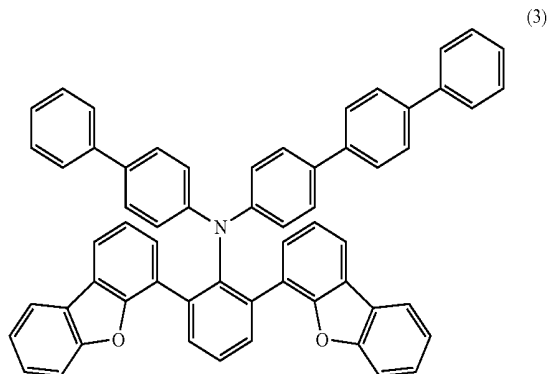

-continued

-continued

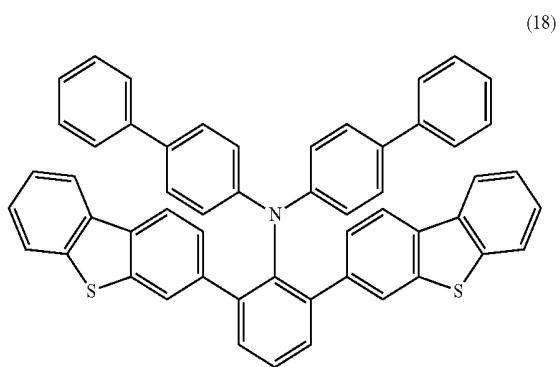
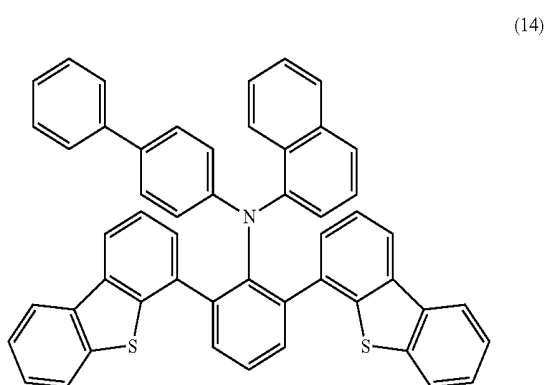
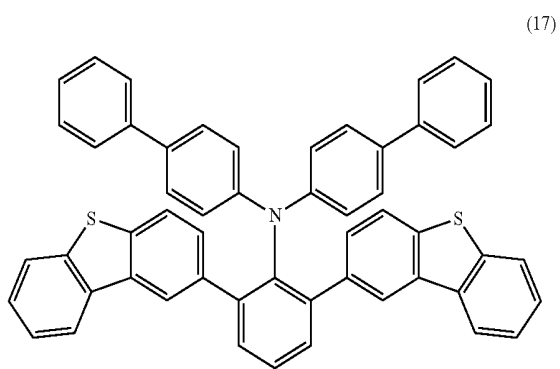
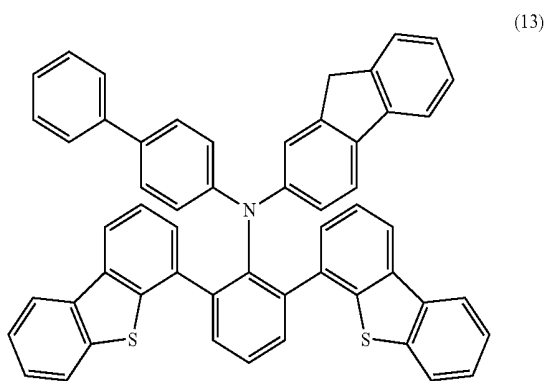
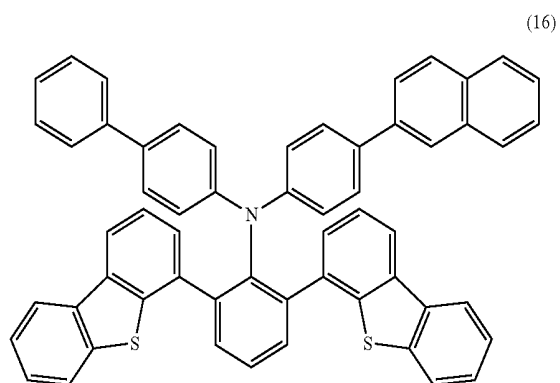
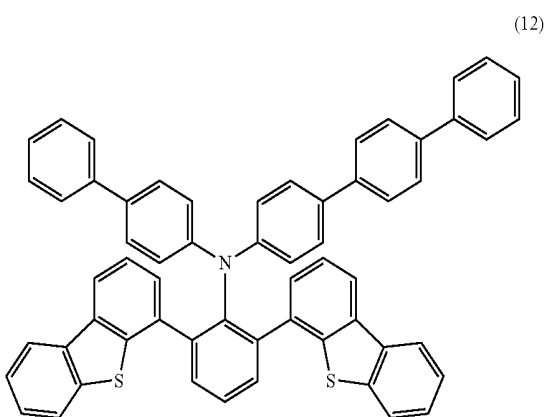
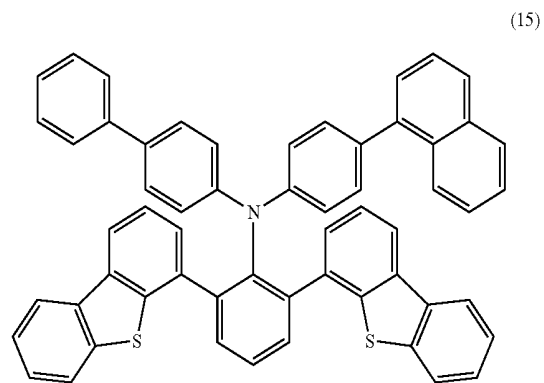
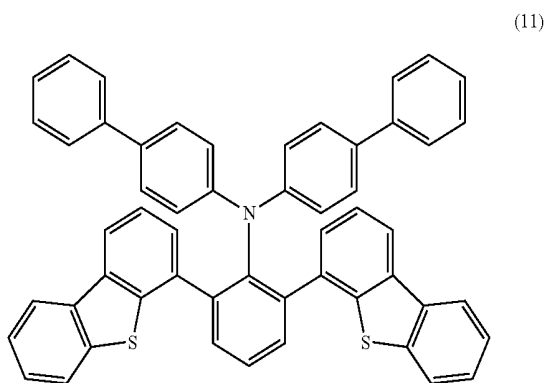

-continued

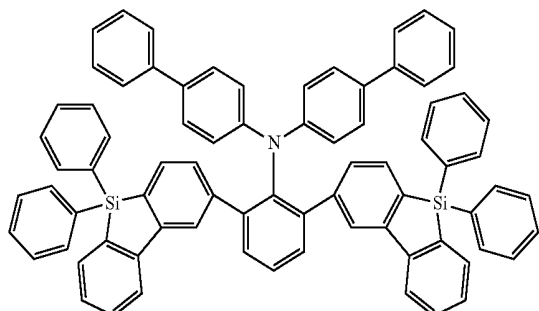
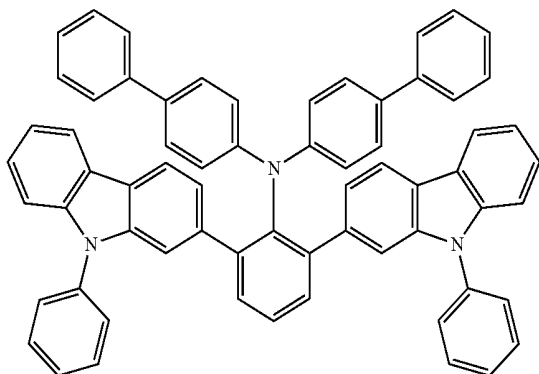
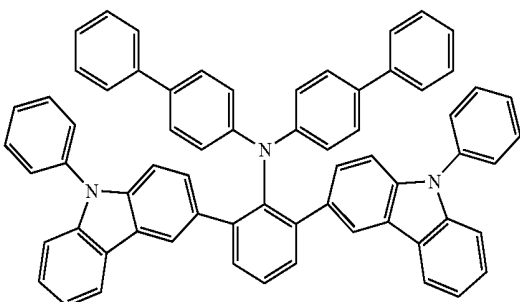
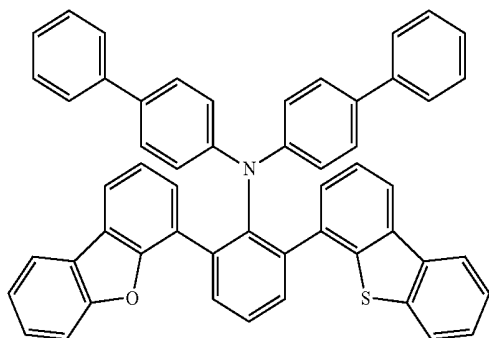

-continued

(23)

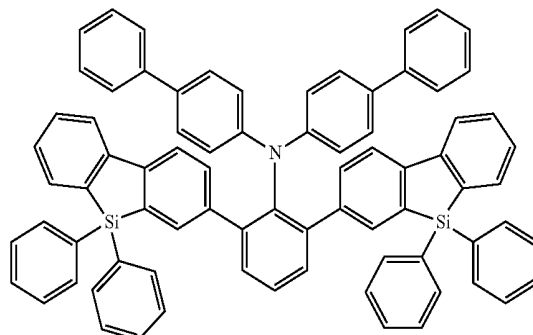

[0037] The material for an organic EL device according to an embodiment of the present disclosure may be included in at least one layer selected from a plurality of organic layers forming an organic EL device. For example, the material may be included in at least one laminated layer between an emission layer and an anode in the organic EL device.

[0038] As described above, the material for an organic EL device according to an embodiment of the present disclosure may be an aniline derivative having a structure in which dibenzoheterole groups are introduced (e.g., coupled) to a phenyl group of a triarylamine at the ortho positions relative to the nitrogen atom. In the material for an organic EL device according to an embodiment of the present disclosure, the polarity of the molecule may be increased due to the heteroatoms of the dibenzoheterole groups, and the energy gap (e.g., HOMO-LUMO gap) of the molecule may be increased due to the large steric distortion of the molecule around the amine group, thereby improving the emission efficiency of the organic EL device.

[0039] The material for an organic EL device according to an embodiment of the present disclosure is not limited to being used as the material included in a layer between an emission layer and an anode in an organic EL device, but may also be used as the material of the emission layer. When the material for an organic EL device according to an embodiment of the present disclosure is used as a material for a hole transport layer, the emission efficiency of the organic EL device may be improved in the blue emission region.

Organic EL Device

[0040] Hereinafter, an organic EL device using a material for an organic EL device according to an embodiment of the present disclosure will be explained. FIG. 1 is a schematic diagram illustrating an organic EL device 100 according to an embodiment of the present disclosure. The organic EL device 100 may include, for example, a substrate 102, an anode 104, a hole injection layer 106, a hole transport layer 108, an emission layer 110, an electron transport layer 112, an electron injection layer 114 and a cathode 116. The material for an organic EL device according to an embodiment of the present disclosure may be used in at least one laminated layer between the emission layer and the anode.

[0041] An embodiment where the material for an organic EL device according to the present disclosure is used in the hole transport layer 108 will be explained in more detail.

[0042] The substrate **102** may be a transparent glass substrate, a semiconductor substrate formed using silicon, and/or a flexible substrate made of a resin, etc.

[0043] The anode **104** may be on the substrate **102** and may be formed using indium tin oxide (ITO), indium zinc oxide (IZO), etc.

[0044] The hole injection layer (HIL) **106** may be formed on the anode **104** to a thickness of about 10 nm to about 150 nm using any suitable material. The material may include, for example, triphenylamine-containing polyether ketone (TPAPEK), 4-isopropyl-4'-methyl-diphenyliodonium tetrakis(pentafluorophenyl)borate (PPBI), N,N'-diphenyl-N,N'-bis-[4-(phenyl-m-tolyl-amino)-phenyl]-biphenyl-4,4'-diamine (DNTPD), a phthalocyanine compound such as copper phthalocyanine, 4,4',4''-tris(3-methylphenylphenylamino) triphenylamine (m-MTDATA), N,N'-di(1-naphthyl)-N,N'-diphenylbenzidine (NPB), 4,4',4''-tris{N,N'-diphenylamino}triphenylamine (TDATA), 4,4',4''-tris(N,N'-2-naphthylphenylamino)triphenylamine (2-TNATA), polyaniline/dodecylbenzenesulfonic acid (PANI/DBSA), poly(3,4-ethylenedioxythiophene)/poly(4-styrenesulfonate) (PEDOT/PSS), polyaniline/camphor sulfonic acid (PANI/CSA), polyaniline/poly(4-styrenesulfonate) (PANI/PSS), etc.

[0045] The hole transport layer (HTL) **108** may be formed on the hole injection layer **106** to a thickness of about 10 nm to about 150 nm using the material for an organic EL device according to an embodiment of the present disclosure. In the case where the material for an organic EL device according to an embodiment of the present disclosure is used as a material for the emission layer (EL) **110**, the hole transport layer **108** may be formed using any suitable hole transport material. The hole transport material may include, for example, 1,1-bis[(di-4-tolylamino)phenyl]cyclohexane (TAPC), a carbazole derivative such as N-phenylcarbazole and polyvinyl carbazole, N,N'-bis(3-methylphenyl)-N,N'-diphenyl-[1,1-biphenyl]-4,4'-diamine (TPD), 4,4',4''-tris(N-carbazolyl)triphenylamine (TCTA), N,N'-di(1-naphthyl)-N,N'-diphenylbenzidine (NPB), etc. In some embodiments, the hole transport material and the material for an organic EL device according to an embodiment of the present disclosure may be combined and used to form the hole transport layer **108**.

[0046] The emission layer (EL) **110** may be formed on the hole transport layer **108** to a thickness of about 10 nm to about 60 nm using any suitable host material. Non-limiting examples of the host material used in the emission layer **110** may include tris(8-quinolinolato)aluminum (Alq3), 4,4'-N,N'-dicarbazole-biphenyl (CBP), poly(N-vinylcarbazole) (PVK), 9,10-di(naphthalene-2-yl)anthracene (ADN), 4,4',4''-tris(N-carbazolyl)triphenylamine (TCTA), (1,3,5-tris(N-phenylbenzimidazole-2-yl)benzene (TPBI), 3-tert-butyl-9,10-di(naphth-2-yl)anthracene (TBADN), distyrylarylene (DSA), 4,4'-bis(9-carbazole)-2,2'-dimethyl-biphenyl (dm-CBP), etc.

[0047] The dopant material of the emission layer **110** may include styryl derivatives (such as 1,4-bis[2-(3-N-ethylcarbazolyl)vinyl]benzene (BCzVB), 4-(di-p-tolylamino)-4'-[(di-p-tolylamino)styryl]stilbene (DPAVB), and N-(4-((E)-2-(6-((E)-4-(diphenylamino)styryl)naphthalen-2-yl)vinyl)phenyl-N-phenylbenzeneamine) (N-BDAVB), perylene and derivatives thereof (such as 2,5,8,11-tetra-t-butylperylene (TBPe)), pyrene and derivatives thereof (such as 1,1-

dipyrene, 1,4-dipyrenylbenzene, and 1,4-bis(N,N-diphenylamino)pyrene), etc. However, the type or kind of dopant is not limited thereto.

[0048] The electron transport layer (ETL) **112** may be formed to a thickness of about 15 nm to about 50 nm on the emission layer **110** using, for example, tris(8-hydroxyquinolinolato)aluminum (Alq3) and/or a material having a nitrogen-containing aromatic ring (for example, a material including a pyridine ring such as 1,3,5-tri[(3-pyridyl)-phen-3-yl]benzene, a material including a triazine ring such as 2,4,6-tris(3'-(pyridin-3-yl)biphenyl-3-yl)1,3,5-triazine, and a material including an imidazole derivative such as 2-(4-N-phenylbenzimidazolyl-1-ylphenyl)-9,10-dinaphthylanthracene).

[0049] The electron injection layer (EIL) **114** may be formed to a thickness of about 0.3 nm to about 9 nm on the electron transport layer **112** using, for example, a material including lithium fluoride (LiF), lithium-8-quinolinato (LiQ), etc.

[0050] The cathode **116** may be on the electron injection layer **114** and may be formed using a metal (such as aluminum (Al), silver (Ag), lithium (Li), magnesium (Mg) and/or calcium (Ca)) and/or a transparent material (such as ITO and/or IZO).

[0051] Each electrode and layer forming the organic EL device according to an embodiment of the present disclosure may be formed using an appropriate or suitable layer forming method according to the material to be used, such as a vacuum evaporation method, a sputtering method, and other coating methods available in the art.

[0052] The efficiency of the organic EL device **100** may be increased by including the material for an organic EL device according to an embodiment of the present disclosure in the hole transport layer.

[0053] In the organic EL device **100** according to an embodiment of the present disclosure, the material for an organic EL device may be used as a material for a hole injection layer or a material for the host material of an emission layer. As described above, the efficiency of an organic EL device may be improved by including the material for an organic EL device in at least one layer selected from a plurality of organic layers forming the organic EL device.

[0054] The material for an organic EL device according to an embodiment of the present disclosure may be applied to an active matrix type (e.g., active matrix) organic EL display using thin film transistors (TFTs). Hereinafter, a method of synthesizing a triarylamine derivative of Formula 1 will be explained in more detail according to example embodiments.

General Synthetic Method of Triarylamine Derivative

[0055] In the synthetic method of a triarylamine derivative as the material for an organic EL device according to an embodiment of the present disclosure, a primary amine derivative may be produced by reacting a 1-amino-2,6-halogenated benzene with a dibenzofuran derivative, a dibenzothiophene derivative, a dibenzosilole derivative, and/or a carbazole derivative substituted with boronic acid in the presence of a catalyst and optional additives. Then, a triarylamine derivative represented by the following Formula 1 may be prepared by reacting the primary amine derivative with an unsubstituted aryl halide group having 6 to 30 carbon atoms for forming a ring or a substituted or

unsubstituted heteroaryl halide group having 1 to 30 carbon atoms for forming a ring in the presence of a catalyst, a base, and optional additives. The reaction yield of the 1-diarylamino-2,6-halogenated benzene and the dibenzoheterole derivative substituted with boronic acid may be very low (e.g., low) due to the steric hindrance of the diarylamino group.

Formula 1

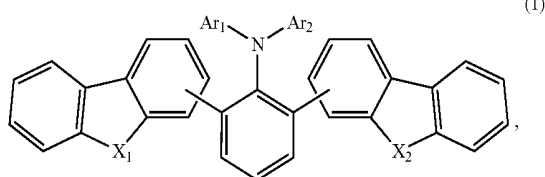

[0056] In Formula 1, Ar₁ and Ar₂ may each independently be selected from a substituted or unsubstituted aryl group having 6 to 30 carbon atoms for forming a ring and a substituted or unsubstituted heteroaryl group having 1 to 30 carbon atoms for forming a ring; X₁ and X₂ may each independently be selected from O, S, R₁—Si—R₂ and N—R₃; and R₁ to R₃ may each independently be selected from an alkyl group having 1 to 10 carbon atoms and an aryl group having 6 to 30 carbon atoms for forming a ring.

[0057] Non-limiting examples of the 1-amino-2,6-halogenated benzene may include 2,6-dichloroaniline, 2,6-dibromoaniline, 2,6-diiodoaniline, 2-bromo-6-iodoaniline, etc.

[0058] Non-limiting examples of the dibenzofuran derivative substituted with boronic acid may include, for example, dibenzofuran-1-boronic acid, dibenzofuran-2-boronic acid, dibenzofuran-3-boronic acid, dibenzofuran-4-boronic acid, etc.

[0059] Non-limiting examples of the dibenzothiophene derivative substituted with boronic acid may include dibenzothiophene-2-boronic acid, dibenzothiophene-3-boronic acid, dibenzothiophene-4-boronic acid, etc.

[0060] Non-limiting examples of the dibenzosilole derivative substituted with boronic acid may include 9,9-dimethyl-9-silafluorene-2-boronic acid, 9,9-dimethyl-9-silafluorene-3-boronic acid, 9,9-diethyl-9-silafluorene-2-boronic acid, 9,9-diethyl-9-silafluorene-3-boronic acid, 9,9-diphenyl-silafluorene-2-boronic acid, 9,9-diphenyl-9-silafluorene-3-boronic acid, etc.

[0061] Non-limiting examples of the carbazole derivative substituted with boronic acid may include 9-methylcarbazolyl-2-boronic acid, 9-methylcarbazolyl-3-boronic acid, 9-ethylcarbazolyl-2-boronic acid, 9-ethylcarbazolyl-3-boronic acid, 9-phenylcarbazolyl-2-boronic acid, 9-phenylcarbazolyl-3-boronic acid, etc.

[0062] Non-limiting examples of the solvent used in the reaction of the 1-amino-2,6-halogenated benzene with the dibenzofuran derivative, the dibenzothiophene derivative, the dibenzosilole derivative, and/or the carbazole derivative substituted with boronic acid to prepare the amine derivative may include toluene, dimethoxyethane, tetrahydrofuran, acetone, acetonitrile, 1,4-dioxane, and mixtures thereof with water. Non-limiting examples of a catalyst for the coupling reaction may include tetrakis(triphenylphosphine)palladium(0), palladium(II) acetate, bis(triphenylphosphine)palladium(II)dichloride, [1,1'-bis(diphenylphosphino)ferrocene]palla-

dium(II)dichloride dichloromethane adduct, dichloro(1,5-cyclooctadiene)palladium(II), [1,1'-bis(di-tert-butylphosphino)ferrocene]palladium(II) dichloride, etc., and non-limiting examples of a base may include sodium carbonate, potassium carbonate, rubidium carbonate, cesium carbonate, tripotassium phosphate, etc. Non-limiting examples of optional additives may include triphenylphosphine, 2-dicyclohexylphosphino-2',6'-bimethoxybiphenyl (SPhos), 2-dicyclohexylphosphino-2',4',6'-triisopropylbiphenyl (XPhos), etc.

[0063] Non-limiting examples of the unsubstituted aryl halide group having 6 to 30 carbon atoms for forming a ring may include dibromobenzene, iodobenzene, 4-bromobiphenyl, 4-iodobiphenyl, 4-bromo-p-terphenyl, 1-bromonaphthalene, 2-bromonaphthalene, 1-iodonaphthalene, 2-iodonaphthalene, 1-(4-bromophenyl)naphthalene, 2-(4-bromophenyl)naphthalene, 2-bromoanthracene, 9-bromoanthracene, 2-bromophenanthrene, 9-bromophenanthrene, 2-bromotriphenylene, 1-bromopyrene, 2-bromopyrene, etc.

[0064] Non-limiting examples of the substituted or unsubstituted heteroaryl halide group having 1 to 30 carbon atoms for forming a ring may include 2-bromodibenzofuran, 3-bromodibenzofuran, 4-bromodibenzofuran, 2-bromodibenzothiophene, 3-bromodibenzothiophene, 4-bromodibenzothiophene, 2-iododibenzofuran, 3-iododibenzofuran, 4-iododibenzofuran, 2-iododibenzothiophene, 3-iododibenzothiophene, 4-iododibenzothiophene, 2-bromo-9-phenylcarbazole, 2-bromo-9-methylcarbazole, 2-bromo-9-ethylcarbazole, 3-bromo-9-phenylcarbazole, 3-bromo-9-methylcarbazole, 3-bromo-9-ethylcarbazole, 2-bromopyridine, 3-bromopyridine, 4-bromopyridine, 2-iodopyridine, 3-iodopyridine, 4-iodopyridine, 2-bromoquinoline, 3-bromoquinoline, 4-bromoquinoline, 5-bromoquinoline, 6-bromoquinoline, 7-bromoquinoline, etc.

[0065] Non-limiting examples of the solvent used in the reaction of the primary amine derivative with the unsubstituted aryl halide group having 6 to 30 carbon atoms for forming a ring, and/or the substituted or unsubstituted heteroaryl halide group having 1 to 30 carbon atoms for forming a ring to prepare the triarylamine derivative represented by Formula 1 may include toluene, xylene, methylene, dimethylformamide, tetrahydrofuran, etc. Non-limiting examples of a catalyst for the coupling reaction may include bis(dibenzylideneacetone)palladium(0), [1,1'-bis(diphenylphosphino)ferrocene]palladium(II)dichloride dichloromethane adduct, tris(dibenzylideneacetone)dipalladium(0), palladium(II) acetate, etc., and non-limiting examples of a base may include sodium tert-butoxide, potassium tert-butoxide, n-butyllithium, etc. Non-limiting examples of optional additives may include tri-tert-butylphosphine, 2-dicyclohexylphosphino-2',6'-bimethoxybiphenyl, 2-dicyclohexylphosphino-2',4',6'-triisopropylbiphenyl, 2,2'-bis(diphenylphosphino)-1,1'-binaphthyl, etc.

Embodiment 1 of Synthetic Method of Triarylamine Derivative

[0066] In the reaction of a 1-amino-2,6-halogenated benzene with a dibenzofuran derivative substituted with boronic acid to prepare a primary amine derivative, a mixture of toluene, water and ethanol is used as a solvent, tetrakis(triphenylphosphine)palladium(0) is used as a catalyst, and potassium carbonate is used as a base. In the reaction of the resulting primary amine derivative with an unsubstituted

potassium carbonate is used as a base. In the reaction of the resulting primary amine derivative with an unsubstituted aryl halide group having 6 to 30 carbon atoms for forming a ring or a substituted or unsubstituted heteroaryl halide group having 1 to 30 carbon atoms for forming a ring, toluene is used as a solvent, bis(dibenzylideneacetone)palladium(0) is used as a catalyst, n-butyllithium is used as a base, and tri-tert-butylphosphine is used as an additive.

Embodiment 10 of Synthetic Method of Triarylamine Derivative

[0075] In the reaction of a 1-amino-2,6-halogenated benzene with a dibenzofuran derivative substituted with boronic acid to prepare a primary amine derivative, a mixture of toluene, water and ethanol is used as a solvent, tetrakis(triphenylphosphine)palladium(0) is used as a catalyst, and sodium carbonate is used as a base. In the reaction of the resulting primary amine derivative with an unsubstituted aryl halide group having 6 to 30 carbon atoms for forming a ring or a substituted or unsubstituted heteroaryl halide group having 1 to 30 carbon atoms for forming a ring, toluene is used as a solvent, bis(dibenzylideneacetone)palladium(0) is used as a catalyst, n-butyllithium is used as a base, and tri-tert-butylphosphine is used as an additive.

Embodiment 11 of Synthetic Method of Triarylamine Derivative

[0076] In the reaction of a 1-amino-2,6-halogenated benzene with a dibenzofuran derivative substituted with boronic acid to prepare a primary amine derivative, a mixture of toluene, water and ethanol is used as a solvent, tetrakis(triphenylphosphine)palladium(0) is used as a catalyst, and tripotassium phosphate is used as a base. In the reaction of the resulting primary amine derivative with an unsubstituted aryl halide group having 6 to 30 carbon atoms for forming a ring or a substituted or unsubstituted heteroaryl halide group having 1 to 30 carbon atoms for forming a ring, toluene is used as a solvent, bis(dibenzylideneacetone)palladium(0) is used as a catalyst, n-butyllithium is used as a base, and tri-tert-butylphosphine is used as an additive.

Embodiment 12 of Synthetic Method of Triarylamine Derivative

[0077] In the reaction of a 1-amino-2,6-halogenated benzene with a dibenzofuran derivative substituted with boronic acid to prepare a primary amine derivative, a mixture of toluene, water and ethanol is used as a solvent, palladium(II) acetate is used as a catalyst, tripotassium phosphate is used as a base, and SPhos is used as an additive. In the reaction of the resulting primary amine derivative with an unsubstituted aryl halide group having 6 to 30 carbon atoms for forming a ring or a substituted or unsubstituted heteroaryl halide group having 1 to 30 carbon atoms for forming a ring, toluene is used as a solvent, bis(dibenzylideneacetone)palladium(0) is used as a catalyst, n-butyllithium is used as a base, and tri-tert-butylphosphine is used as an additive.

Embodiment 13 of Synthetic Method of Triarylamine Derivative

[0078] In the reaction of a 1-amino-2,6-halogenated benzene with a dibenzofuran derivative substituted with boronic acid to prepare a primary amine derivative, a mixture of toluene, water and ethanol is used as a solvent, palladium(II)

acetate is used as a catalyst, potassium carbonate is used as a base, and SPhos is used as an additive. In the reaction of the resulting primary amine derivative with an unsubstituted aryl halide group having 6 to 30 carbon atoms for forming a ring or a substituted or unsubstituted heteroaryl halide group having 1 to 30 carbon atoms for forming a ring, toluene is used as a solvent, bis(dibenzylideneacetone)palladium(0) is used as a catalyst, n-butyllithium is used as a base, and tri-tert-butylphosphine is used as an additive.

Embodiment 14 of Synthetic Method of Triarylamine Derivative

[0079] In the reaction of a 1-amino-2,6-halogenated benzene with a dibenzofuran derivative substituted with boronic acid to prepare a primary amine derivative, a mixture of toluene, water and ethanol is used as a solvent, palladium(II) acetate is used as a catalyst, sodium carbonate is used as a base, and SPhos is used as an additive. In the reaction of the resulting primary amine derivative with an unsubstituted aryl halide group having 6 to 30 carbon atoms for forming a ring or a substituted or unsubstituted heteroaryl halide group having 1 to 30 carbon atoms for forming a ring, toluene is used as a solvent, bis(dibenzylideneacetone)palladium(0) is used as a catalyst, n-butyllithium is used as a base, and tri-tert-butylphosphine is used as an additive.

Embodiment 15 of Synthetic Method of Triarylamine Derivative

[0080] In the reaction of a 1-amino-2,6-halogenated benzene with a dibenzofuran derivative substituted with boronic acid to prepare a primary amine derivative, a mixture of toluene, water and ethanol is used as a solvent, tetrakis(triphenylphosphine)palladium(0) is used as a catalyst, and cesium carbonate is used as a base. In the reaction of the resulting primary amine derivative with an unsubstituted aryl halide group having 6 to 30 carbon atoms for forming a ring or a substituted or unsubstituted heteroaryl halide group having 1 to 30 carbon atoms for forming a ring, toluene is used as a solvent, bis(dibenzylideneacetone)palladium(0) is used as a catalyst, n-butyllithium is used as a base, and tri-tert-butylphosphine is used as an additive.

Embodiment 16 of Synthetic Method of Triarylamine Derivative

[0081] In the reaction of a 1-amino-2,6-halogenated benzene with a dibenzofuran derivative substituted with boronic acid to prepare a primary amine derivative, a mixture of toluene, water and ethanol is used as a solvent, palladium(II) acetate is used as the catalyst, cesium carbonate is used as a base, and SPhos is used as an additive. In the reaction of the resulting primary amine derivative with an unsubstituted aryl halide group having 6 to 30 carbon atoms for forming a ring or a substituted or unsubstituted heteroaryl halide group having 1 to 30 carbon atoms for forming a ring, toluene is used as a solvent, bis(dibenzylideneacetone)palladium(0) is used as a catalyst, n-butyllithium is used as a base, and tri-tert-butylphosphine is used as an additive.

EXAMPLES

Synthetic Examples of Compounds

General Synthetic Method 1

[0082] Under an argon atmosphere, a boronic acid derivative, tetrakis(triphenylphosphine)palladium(0), and potas-

sium carbonate were added to a 1-amino-2,6-halogenated benzene, followed by heating and stirring in a mixture solvent of toluene, water and ethanol (10:2:1) (controlling the concentration of the halogenated benzene at about 0.1 M) at about 80° C. for about 10 hours. After cooling, water was added, the organic phase was separated and dried with magnesium sulfate, and solvents were distilled. The crude product thus obtained was separated by silica gel column chromatography (toluene/hexane) to produce a purified product.

Synthesis of Compound A

[0083] Synthetic method 1 was conducted using 2,6-dibromoaniline (10.0 g), dibenzofuran-4-boronic acid (2 eq.), tetrakis(triphenylphosphine)palladium(0) (0.1 mol %) and potassium carbonate (4 eq.). 13.5 g of Compound A was produced (Yield: 80%). The molecular weight of the product thus obtained was measured by fast atom bombardment (FAB-MS) to be 425, and the chemical formula thereof was taken to be $C_{30}H_{19}NO_2$, corresponding to Compound A.

Formula 4

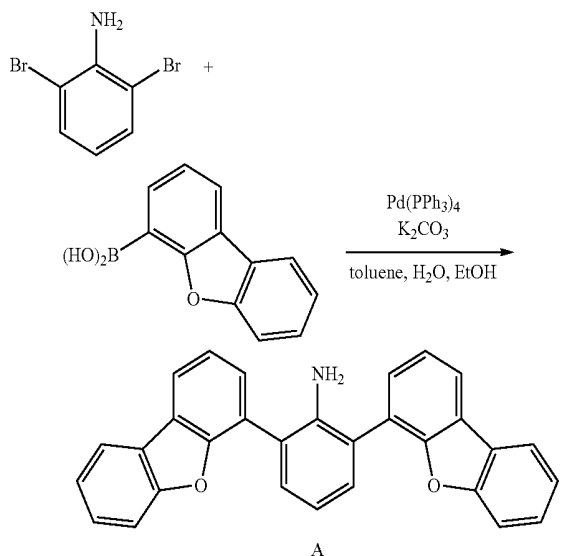

Synthesis of Compound B

[0084] Synthetic method 1 was conducted using 2,6-dibromoaniline (3.0 g), dibenzofuran-4-boronic acid (1 eq.), tetrakis(triphenylphosphine)palladium(0) (0.05 mol %) and potassium carbonate (2 eq.). 2.2 g of Compound B was produced (Yield: 55%). The molecular weight of the product thus obtained was measured by FAB-MS to be 337, and the chemical formula thereof was taken to be $C_{18}H_{12}BrNO$, corresponding to Compound B.

Formula 5

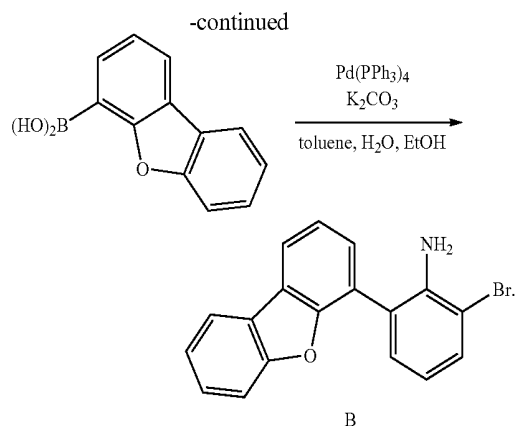
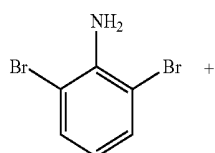

Synthesis of Compound C

[0085] Synthetic method 1 was conducted using 2,6-dibromoaniline (10.0 g), dibenzothiophene-4-boronic acid (2 eq.), tetrakis(triphenylphosphine)palladium(0) (0.1 mol %) and potassium carbonate (4 eq.). 13.5 g of Compound C was produced (Yield: 80%). The molecular weight of the product thus obtained was measured by FAB-MS to be 457, and the chemical formula thereof was taken to be $C_{30}H_{19}NS_2$, corresponding to Compound C.

Formula 6

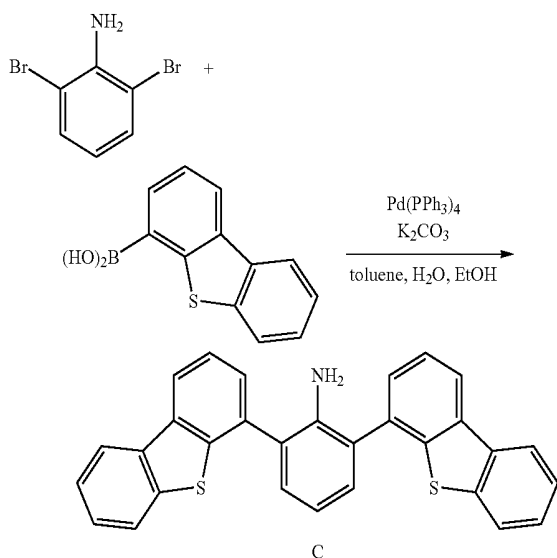

Synthesis of Compound D

[0086] Synthetic method 1 was conducted using Compound B (2.2 g), dibenzothiophene-4-boronic acid (1 eq.), tetrakis(triphenylphosphine)palladium(0) (0.05 mol %) and potassium carbonate (2 eq.). 2.3 g of Compound D was produced (Yield 83%). The molecular weight of the product thus obtained was measured by FAB-MS to be 441, and the chemical formula thereof was taken to be $C_{30}H_{19}NOS$, corresponding to Compound D.

Formula 7

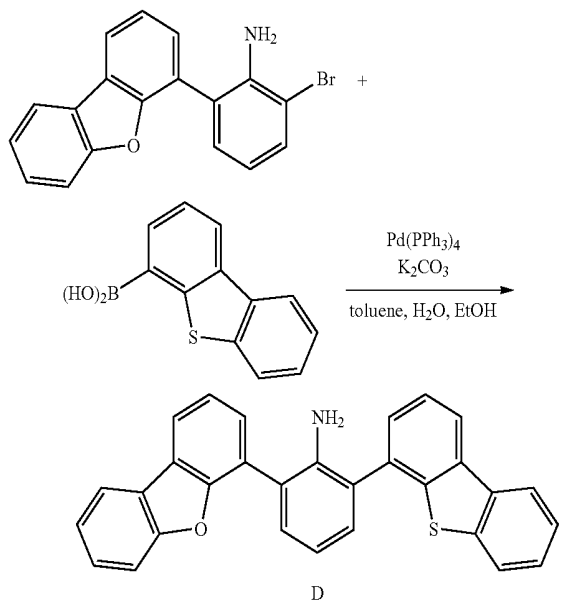

Synthetic Method 2

[0087] Under an argon atmosphere, an aryl halide or heteroaryl halide, bis(dibenzylideneacetone)palladium(0), tri-tert-butylphosphine, and sodium tert-butoxide were added to a primary amine derivative, followed by heating and refluxing in a toluene solvent (controlling the concentration of the primary amine derivative at about 0.1 M) for about 4 hours. After cooling, water was added, the organic phase was separated and dried with magnesium sulfate, and solvents were distilled. The crude product thus obtained was separated by silica gel column chromatography (toluene/hexane) to produce the purified target product.

Synthesis of Compound E

[0088] Synthetic method 2 was conducted using Compound A (10.0 g), 4-bromobiphenyl (1 eq.), bis(dibenzylideneacetone)palladium(0) (5 mol %), tri-tert-butylphosphine (20 mol %), and sodium tert-butoxide (1.5 eq.). 13.5 g of Compound E was produced (Yield: 80%). The molecular weight of the product thus obtained was measured by FAB-MS to be 577, and the chemical formula thereof was taken to be $C_{42}H_{27}NO_2$, corresponding to Compound E.

Formula 8

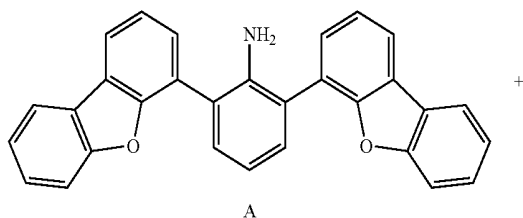

-continued

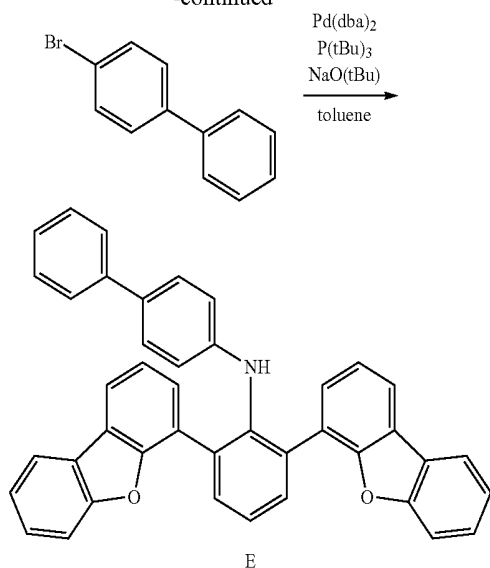

Synthesis of Compound 2

[0089] Synthetic method 2 was conducted using Compound A (2.0 g), 4-bromobiphenyl (2 eq.), bis(dibenzylideneacetone)palladium(0) (10 mol %), tri-tert-butylphosphine (40 mol %) and sodium tert-butoxide (3 eq.). 3.0 g of Compound 2 was produced (Yield: 88%). The molecular weight of the product thus obtained was measured by FAB-MS to be 729, and the chemical formula thereof was taken to be $C_{54}H_{35}NO_2$, corresponding to Compound 2.

Synthesis of Compound 4

[0090] Synthetic method 2 was conducted using Compound E (2.0 g), 3-bromodibenzofuran (1 eq.), bis(dibenzylideneacetone)palladium(0) (5 mol %), tri-tert-butylphosphine (20 mol %) and sodium tert-butoxide (1.5 eq.). 2.2 g of Compound 4 was produced (Yield: 86%). The molecular weight of the product thus obtained was measured by FAB-MS to be 743, and the chemical formula thereof was taken to be $C_{54}H_{33}NO_3$, corresponding to Compound 4.

Synthesis of Compound 6

[0091] Synthetic method 2 was conducted using Compound E (2.0 g), 1-(4-bromophenyl)naphthalene (1 eq.), bis(dibenzylideneacetone)palladium(0) (5 mol %), tri-tert-butylphosphine (20 mol %) and sodium tert-butoxide (1.5 eq.). 2.1 g of Compound 6 was produced (Yield 78%). The molecular weight of the product thus obtained was measured by FAB-MS to be 779, and the chemical formula thereof was taken to be $C_{58}H_{37}NO_2$, corresponding to Compound 6.

Synthesis of Compound 11

[0092] Synthetic method 2 was conducted using Compound C (2.0 g), 4-bromobiphenyl (2 eq.), bis(dibenzylideneacetone)palladium(0) (10 mol %), tri-tert-butylphosphine (40 mol %) and sodium tert-butoxide (3 eq.). 2.8 g of Compound 11 was produced (Yield: 84%). The molecular weight of the product thus obtained was measured by FAB-MS to be 761, and the chemical formula thereof was taken to be $C_{54}H_{35}NS_2$, corresponding to Compound 11.

Synthesis of Compound 19

[0093] Synthetic method 2 was conducted using Compound D (2.0 g), 4-bromobiphenyl (2 eq.), bis(dibenzylideneacetone)palladium(0) (10 mol %), tri-tert-butylphosphine (40 mol %) and sodium tert-butoxide (3 eq.). 3.0 g of Compound 19 was produced (Yield: 89%). The molecular weight of the product thus obtained was measured by FAB-MS to be 745, and the chemical formula thereof was taken to be $C_{54}H_{35}NOS$, corresponding to Compound 19.

[0094] Organic EL devices according to Examples 1 to 7 were manufactured using Compounds 2, 4, 6, 11 and 19 as hole transport materials (collectively referred to as Formula 9), synthesized by the above-described manufacturing methods.

Formula 9

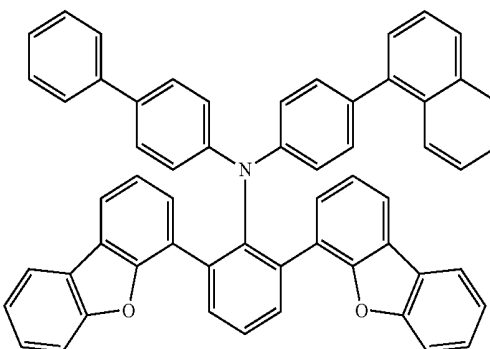
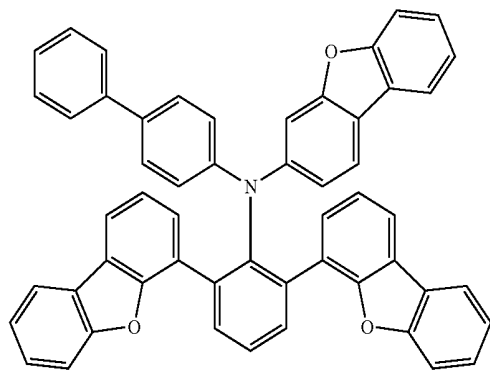
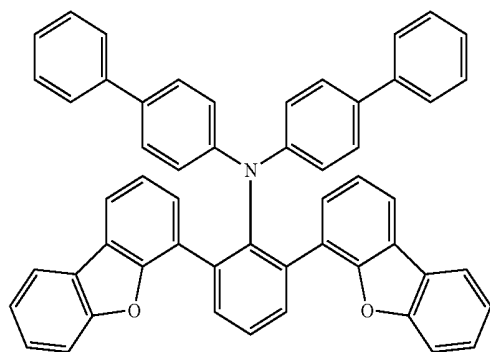

-continued

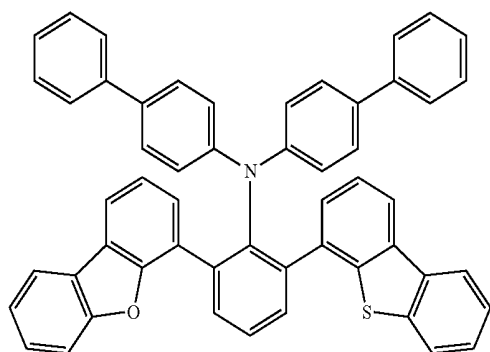
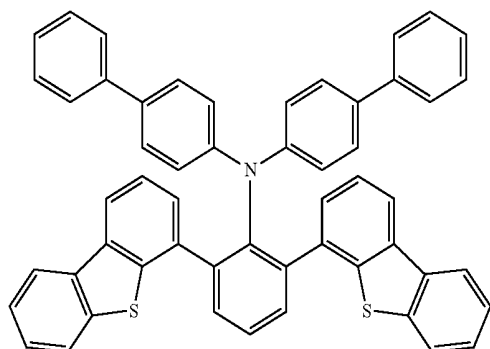

[0095] For comparison, organic EL devices according to Comparative Examples 1 and 2 were manufactured using the following Comparative Compounds C1 and C2 (collectively referred to as Formula 10) as hole transport materials.

Formula 10

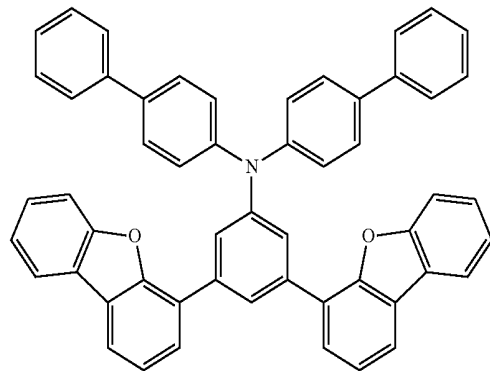
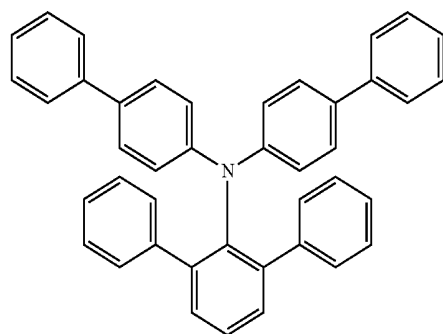

[0096] An organic EL device **200** according to an embodiment of the present disclosure is shown in FIG. 2. In this embodiment, a substrate **202** was formed using a transparent glass substrate, and an anode **204** was formed using ITO to a thickness of about 150 nm. A hole injection layer **206** was formed using 2-TNATA to a thickness of about 60 nm, a hole transport layer **208** was formed to a thickness of about 30 nm, and an emission layer **210** was formed using ADN doped with 3% TBP to a thickness of about 25 nm. An electron transport layer **212** was formed using Alq3 to a thickness of about 25 nm, an electron injection layer **214** was formed using LiF to a thickness of about 1 nm, and a cathode **216** was formed using Al to a thickness of about 100 nm.

[0097] For the organic EL devices **200** thus manufactured, emission efficiencies were evaluated. The emission efficiencies were measured at a current density of 10 mA/cm². The evaluation results are shown in the following Table 1. The brightness light distribution characteristics measurement system of HAMAMATSU Photonics Co. was used in evaluating the emission properties of the organic EL devices.

TABLE 1

Device manufacturing example	Hole transport layer	Emission efficiency
Example 1	Example Compound 2	1.4
Example 2	Example Compound 4	1.4
Example 3	Example Compound 6	1.6
Example 4	Example Compound 11	1.4
Example 5	Example Compound 19	1.5
Comparative Example 1	Comparative Compound C1	1
Comparative Example 2	Comparative Compound C2	1.1

[0098] Referring to the results in Table 1, the organic EL devices of Examples 1 to 5 exhibited higher emission efficiencies than Comparative Examples 1 and 2. The material for an organic EL device according to an embodiment of the present disclosure is an aniline derivative having a structure in which dibenzoheterole groups are bonded (e.g., coupled) to a phenyl group of a triarylamine at the ortho positions relative to the nitrogen atom. Accordingly, a conjugation system may not be increased (e.g., pi conjugation in the molecule may be limited), and an energy gap may not increase in the material (e.g., a small HOMO-LUMO gap may be maintained), and the emission efficiency of the organic EL device may be improved. Comparative Example 1 contains Comparative Compound C1, which contains phenyl groups at the ortho positions. The molecule is not substantially polar, and the emission efficiency is deteriorated or reduced when compared to that of Examples 1 to 5. Comparative Example 2 contains Comparative Compound C2, in which dibenzoheterole groups are introduced (e.g., coupled) at the meta positions. The molecule is not substantially polar, and the emission efficiency is deteriorated.

[0099] From the results in Table 1, the organic EL devices using the materials for an organic EL device of the present disclosure as hole transport materials were recognized to have higher efficiency when compared to those using the comparative compounds. Since the material for an organic EL device according to the present disclosure is an aniline derivative having a structure in which dibenzoheterole groups are bonded (e.g., coupled) to a phenyl group of a triarylamine at the ortho positions relative to the nitrogen atom, the polarity of the molecule may be increased due to

the heteroatoms of the dibenzoheterole groups, and an energy gap (e.g., HOMO-LUMO gap) may be enlarged or increased due to the large steric distortion of the molecule around the amine group, thereby improving the emission efficiency of the organic EL device.

[0100] The material for an organic EL device according to an embodiment of the present disclosure may be an aniline derivative having a structure in which dibenzoheterole groups are introduced (e.g., coupled) to a phenyl group of a triarylamine at the ortho positions relative to the nitrogen atom. The polarity of the molecule may be increased due to the heteroatoms of the dibenzoheterole groups, and an energy gap (e.g., HOMO-LUMO gap) may be enlarged owing to the large steric distortion of the molecule around the amine group. Accordingly, a conjugation system may not be increased (e.g., pi conjugation in the molecule may be limited), and an energy gap (e.g., HOMO-LUMO gap) may be enlarged or increased. Thus, the emission efficiency of the organic EL device may be improved. In addition, since the material for an organic EL device has a wide energy gap, application of embodiments of the present disclosure to organic EL devices in the green and red emission regions may be possible.

[0101] In the present disclosure, an aniline derivative having a structure in which dibenzoheterole groups are introduced (e.g., coupled) to a phenyl group of a triarylamine at the ortho positions relative to the nitrogen atom. Accordingly, the polarity of the molecule may be increased due to the heteroatoms of the dibenzoheterole groups, and an energy gap (e.g., HOMO-LUMO gap) may be increased due to the large steric distortion of the molecule around the amine group. Therefore, a material for an organic EL device having high device efficiency and high emission efficiency, an organic EL device including the same, and a method of preparing the material may be provided.

[0102] As used herein, expressions such as “at least one of” and “one of”, when preceding a list of elements, modify the entire list of elements and do not modify the individual elements of the list. Further, the use of “may” when describing embodiments of the present disclosure refers to “one or more embodiments of the present disclosure”.

[0103] In addition, as used herein, the terms “use”, “using”, and “used” may be considered synonymous with the terms “utilize”, “utilizing”, and “utilized”, respectively.

[0104] As used herein, the terms “substantially”, “about”, and similar terms are used as terms of approximation and not as terms of degree, and are intended to account for the inherent deviations in measured or calculated values that would be recognized by those of ordinary skill in the art.

[0105] Also, any numerical range recited herein is intended to include all subranges of the same numerical precision subsumed within the recited range. For example, a range of “1.0 to 10.0” is intended to include all subranges between (and including) the recited minimum value of 1.0 and the recited maximum value of 10.0, that is, having a minimum value equal to or greater than 1.0 and a maximum value equal to or less than 10.0, such as, for example, 2.4 to 7.6. Any maximum numerical limitation recited herein is intended to include all lower numerical limitations subsumed therein and any minimum numerical limitation recited in this specification is intended to include all higher numerical limitations subsumed therein. Accordingly, Applicant reserves the right to amend this specification, including

the claims, to expressly recite any sub-range subsumed within the ranges expressly recited herein.

[0106] The above-disclosed subject matter is to be considered illustrative and not restrictive, and the appended claims are intended to cover all such modifications, enhancements, and other embodiments, which fall within the true spirit and scope of the present disclosure. Thus, to the maximum extent allowed by law, the scope of the present disclosure is to be determined by the broadest permissible interpretation of the following claims and their equivalents, and shall not be restricted or limited by the foregoing detailed description.

What is claimed is:

1. A material for an organic electroluminescent (EL) device, represented by Formula 1:

Formula 1

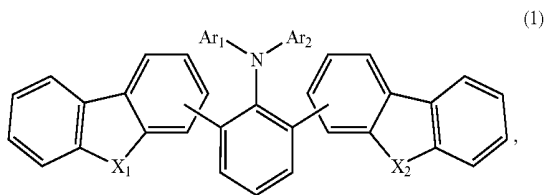

wherein Ar_1 and Ar_2 are each independently selected from a substituted or unsubstituted aryl group having 6 to 30 carbon atoms for forming a ring and a substituted or unsubstituted heteroaryl group having 1 to 30 carbon atoms for forming a ring, and

X_1 and X_2 are each independently selected from O, S, R_1-Si-R_2 , and $N-R_3$, and R_1 to R_3 are each independently selected from an alkyl group having 1 to 10 carbon atoms and an aryl group having 6 to 30 carbon atoms for forming a ring.

2. The material for an organic EL device of claim 1, wherein X_1 and X_2 are each independently selected from O and S.

3. The material for an organic EL device of claim 1, wherein Ar_1 and Ar_2 are each independently selected from a naphthyl group, a biphenyl group, a terphenyl group and a naphthylphenyl group.

4. The material for an organic EL device of claim 1, wherein Ar_1 and Ar_2 are each independently selected from a dibenzofuryl group and a dibenzothiophenyl group.

5. The material for an organic EL device of claim 1, wherein substituents of Ar_1 and Ar_2 are selected from an alkyl group having 1 to 6 carbon atoms, an alkoxy group having 1 to 6 carbon atoms, and a phenyl group.

6. The material for an organic EL device of claim 1, wherein R_1 to R_3 are each independently selected from a methyl group, an ethyl group, an n-propyl group, an i-propyl group, an n-butyl group, an s-butyl group, a t-butyl group, an n-pentyl group, an n-hexyl group, a c-propyl group, a c-butyl group, a c-pentyl group and a c-hexyl group.

7. The material for an organic EL device of claim 1, wherein R_1 to R_3 are each independently selected from a phenyl group, a naphthyl group, an anthracenyl group, a phenanthryl group, a biphenyl group, a terphenyl group, a quaterphenyl group, a fluorenyl group, a triphenylenyl group, a pyrenyl group, a benzofluoranthenyl group, a chrysenyl group, a phenylnaphthyl group and a naphthylphenyl group.

8. The material for an organic EL device of claim 1, wherein the material for an organic EL device is one selected from the compounds of Formula 2:

Formula 2

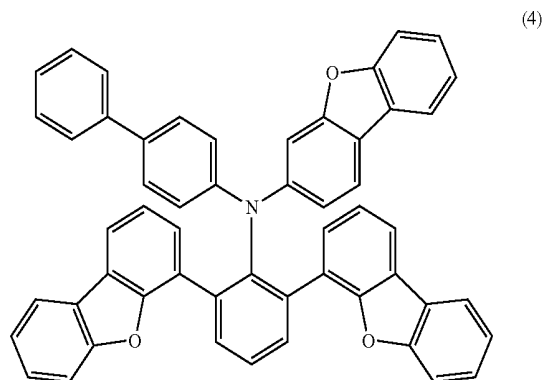
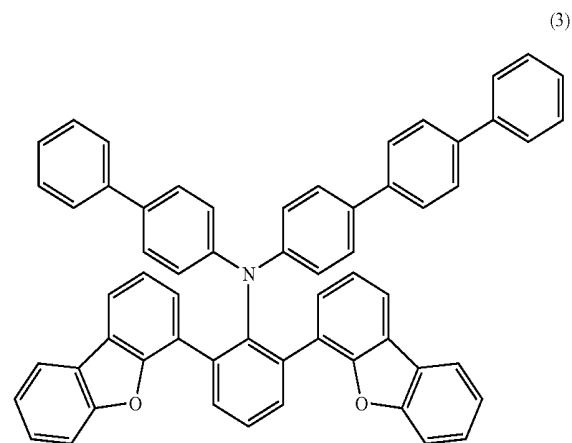
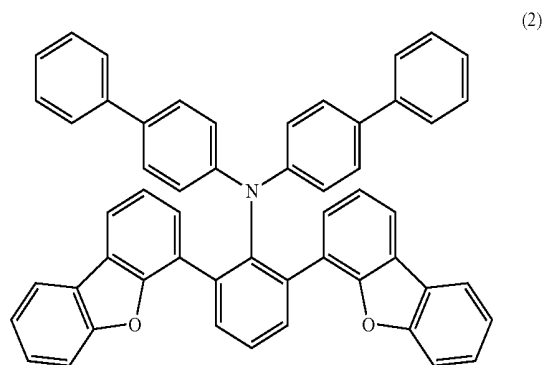

-continued

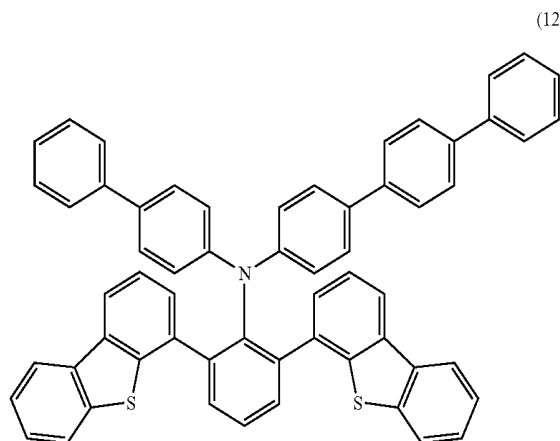
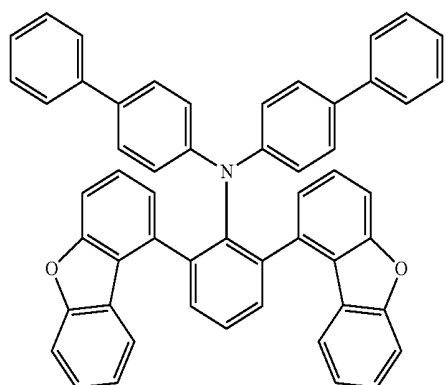
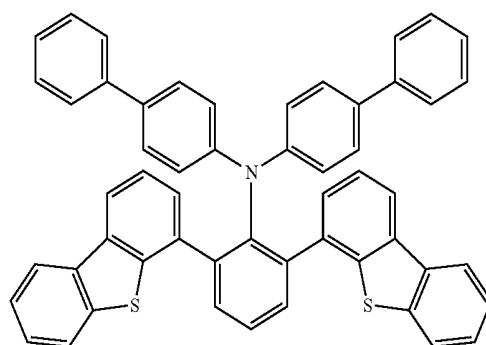
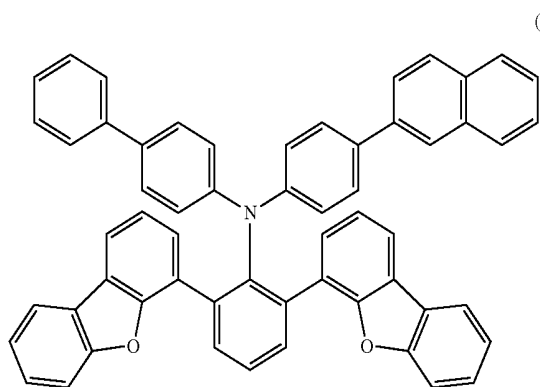
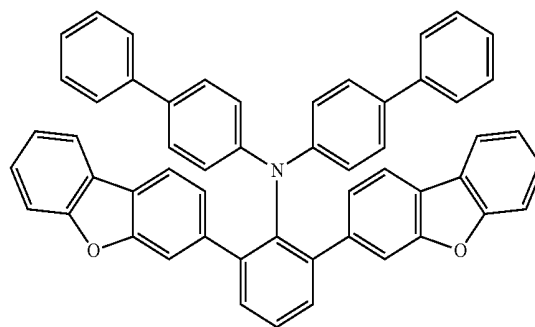
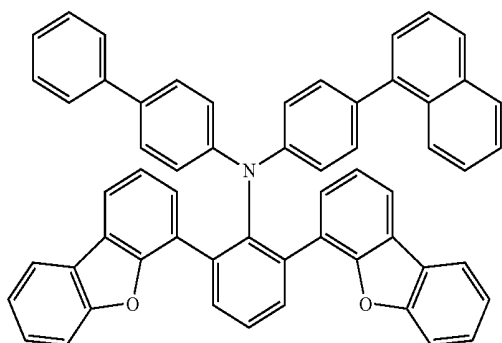
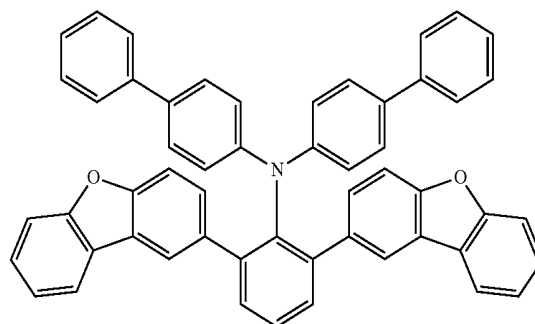
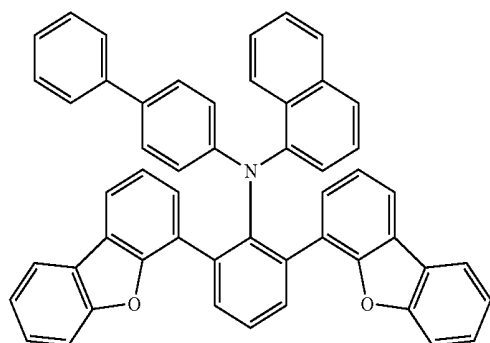

-continued

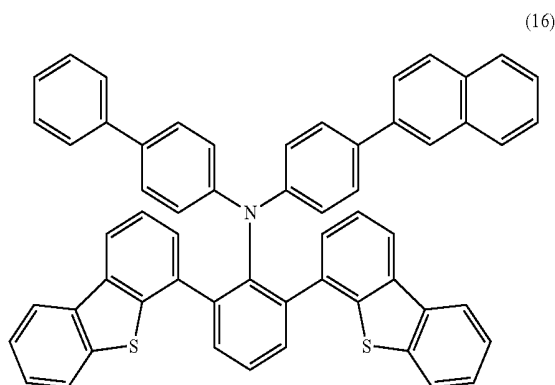
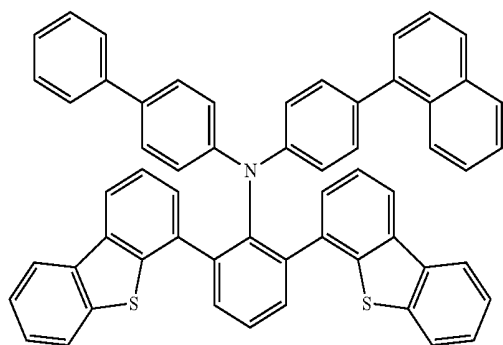
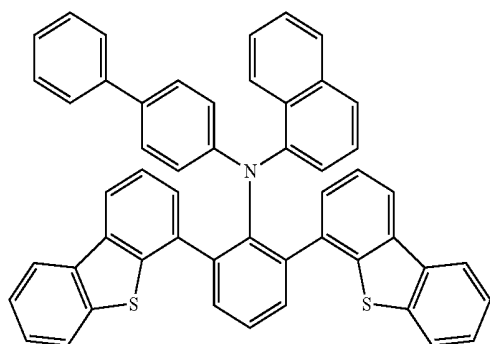
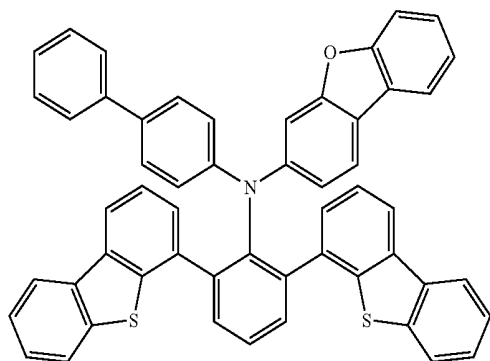

-continued

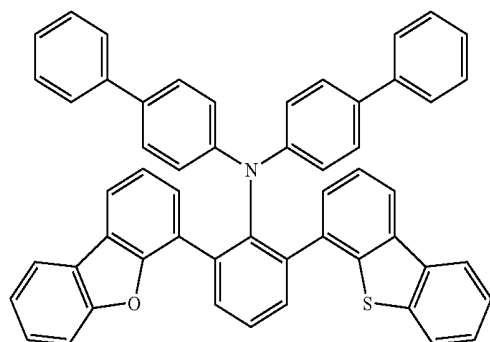
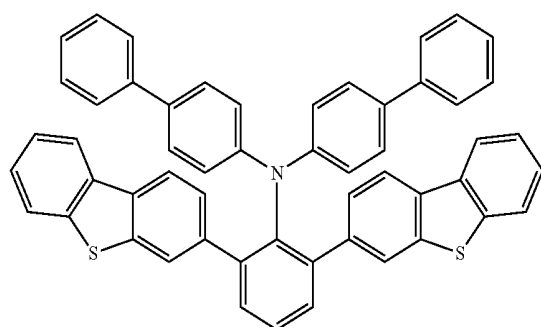
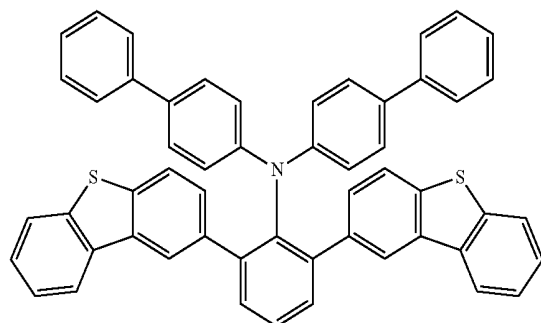

9. The material for an organic EL device of claim 1, wherein the material for an organic EL device is one selected from the compounds of Formula 3:

Formula 3

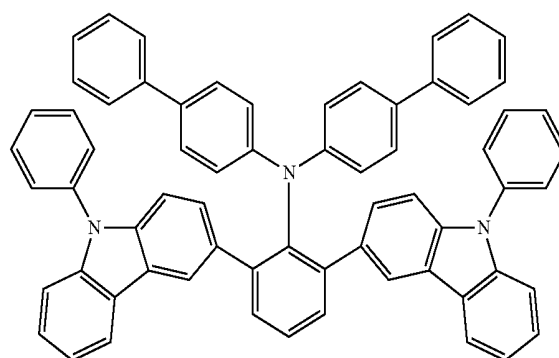

-continued

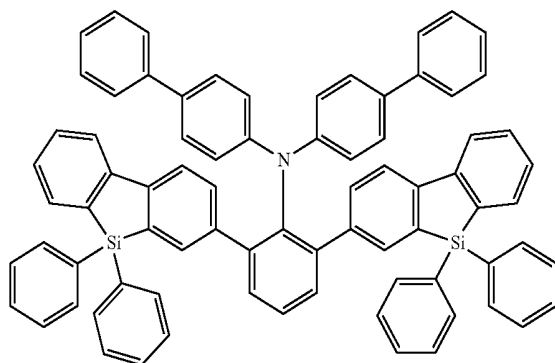
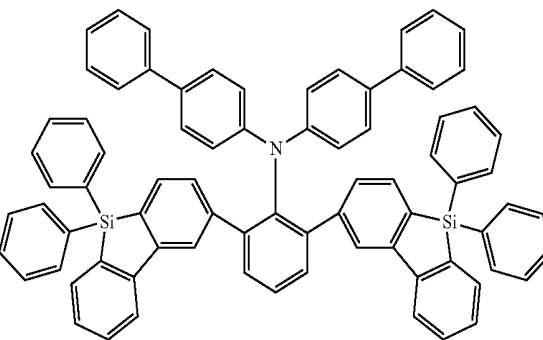
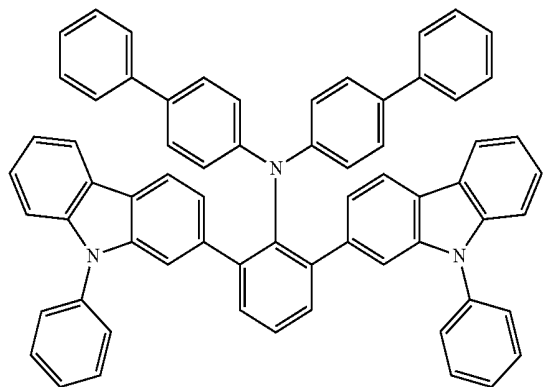

10. An organic electroluminescent (EL) device, comprising:
 an anode;
 an emission layer on the anode; and
 a laminated layer between the anode and the emission layer,
 wherein at least one selected from the emission layer and the laminated layer comprises a material for an organic EL device represented by Formula 1:

Formula 1

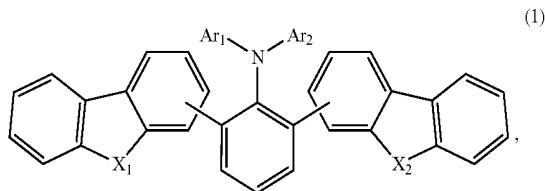

wherein Ar₁ and Ar₂ are each independently selected from a substituted or unsubstituted aryl group having 6 to 30 carbon atoms for forming a ring and a substituted or unsubstituted heteroaryl group having 1 to 30 carbon atoms for forming a ring, and

X₁ and X₂ are each independently selected from O, S, R₁-Si-R₂, and N-R₃, and R₁ to R₃ are each independently selected from an alkyl group having 10 and less carbon atoms and an aryl group having 6 to 30 carbon atoms for forming a ring.

11. The organic EL device of claim 10, wherein the laminated layer comprises a hole transport layer, and the hole transport layer comprises the material for an organic EL device.

12. The organic EL device of claim 10, wherein X₁ and X₂ are each independently selected from O and S.

13. The organic EL device of claim 10, wherein Ar₁ and Ar₂ are each independently selected from a naphthyl group, a biphenyl group, a terphenyl group and a naphthylphenyl group.

14. The organic EL device of claim 10, wherein Ar₁ and Ar₂ are each independently selected from a dibenzofuryl group and a dibenzothiophenyl group.

15. The organic EL device of claim 10, wherein the material for an organic EL device is one selected from the compounds of Formula 2:

Formula 2

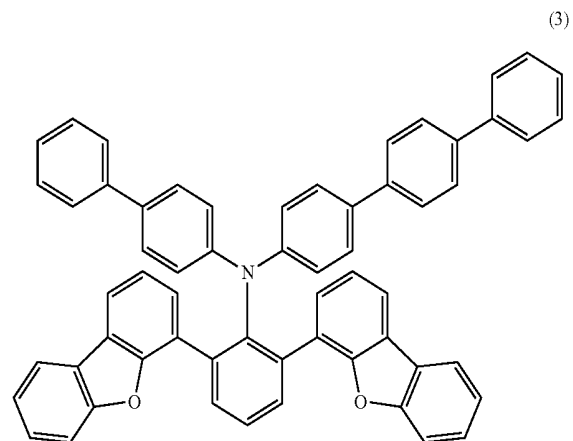
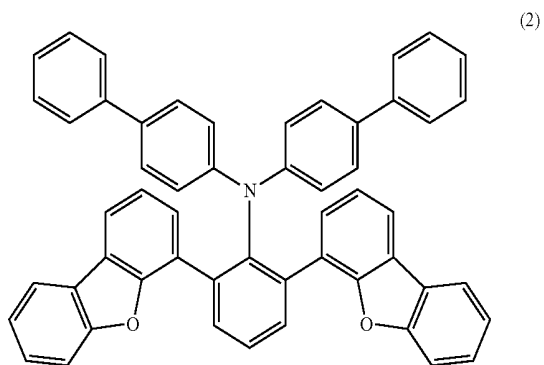

-continued

-continued

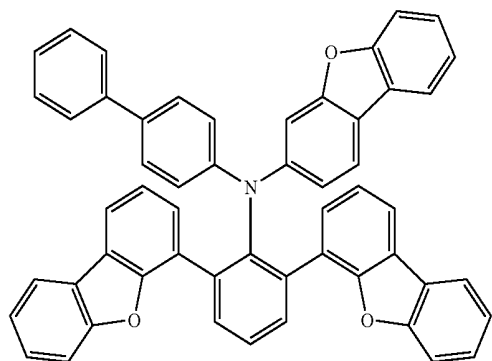

(4)

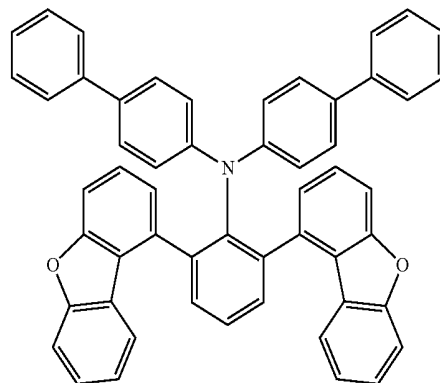

(8)

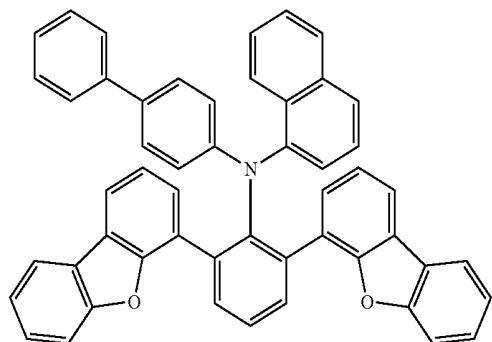

(5)

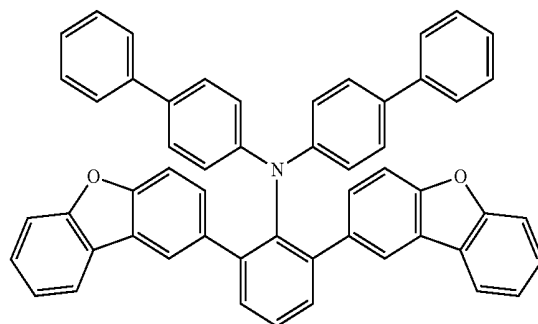

(9)

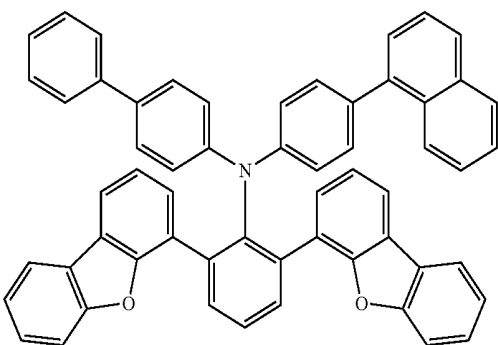

(6)

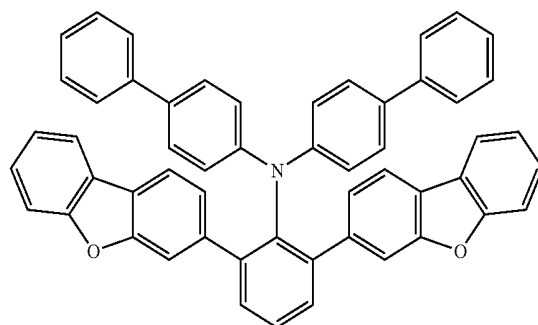

(10)

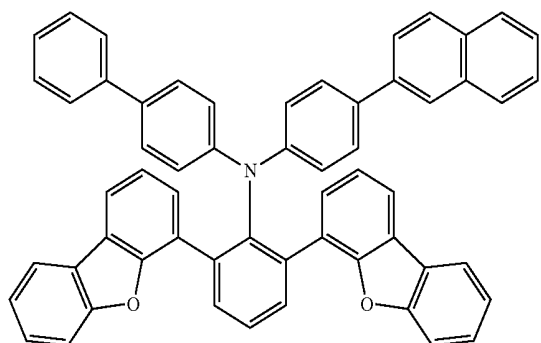

(7)

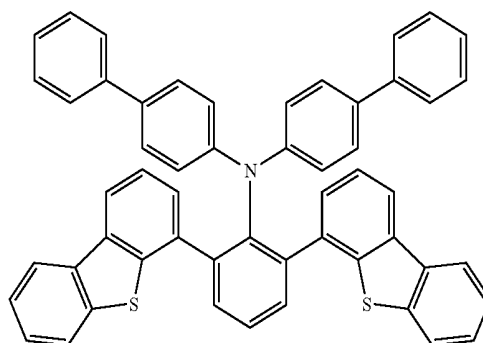

(11)

-continued

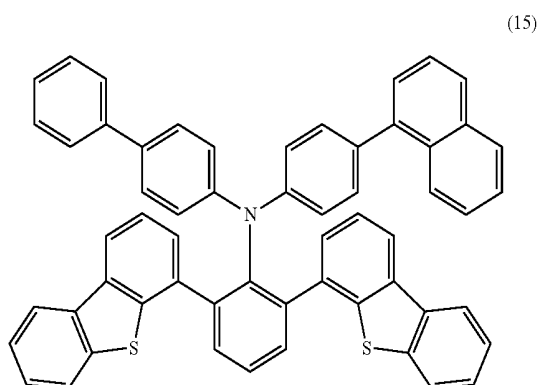
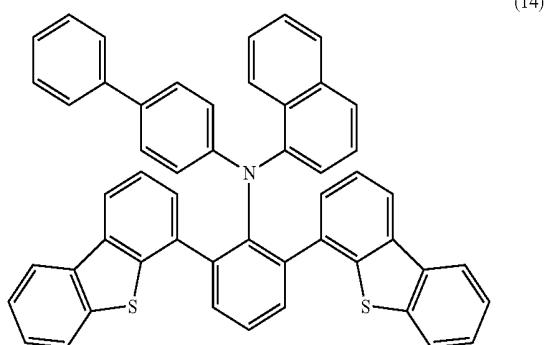
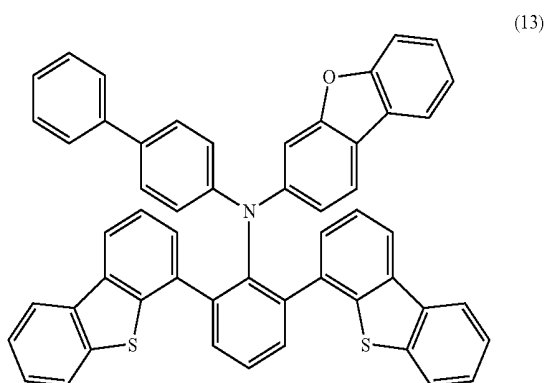
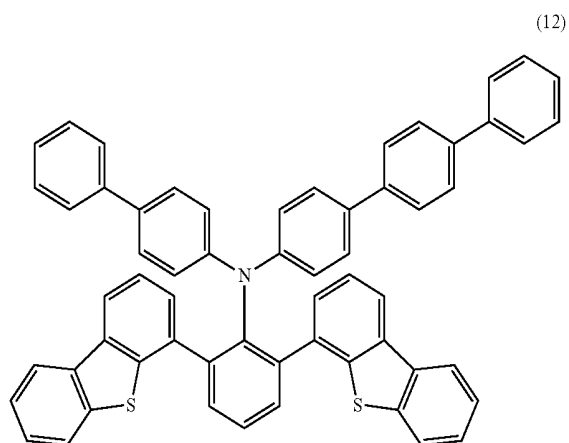

-continued

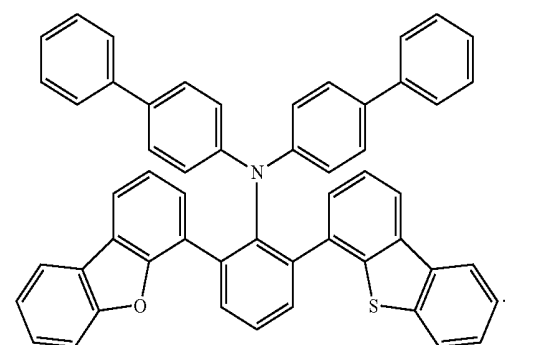
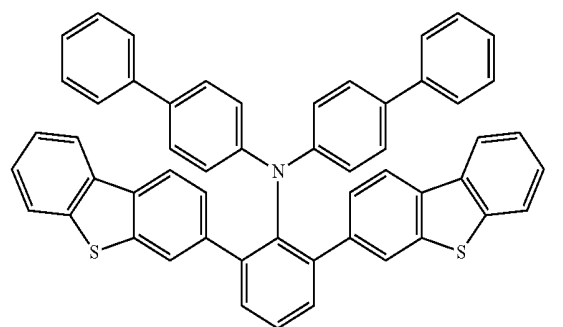
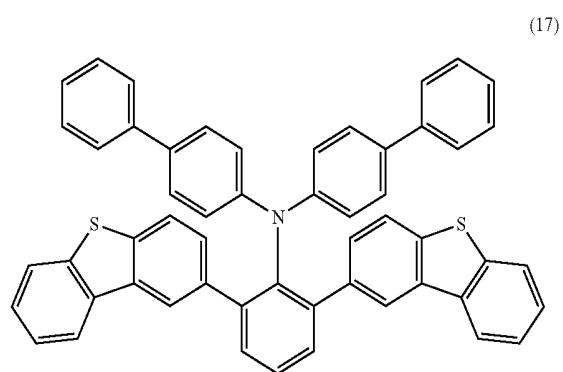
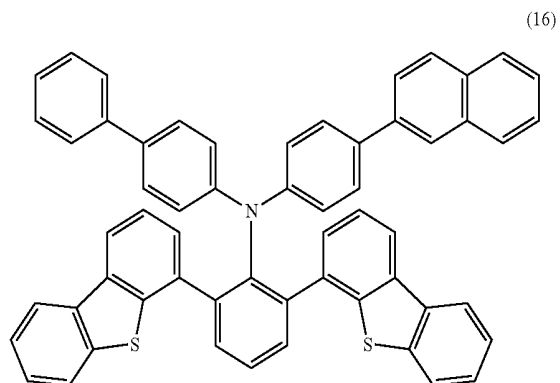

16. The organic EL device of claim 10, wherein the material for an organic EL device is one selected from the compounds of Formula 3:

Formula 3

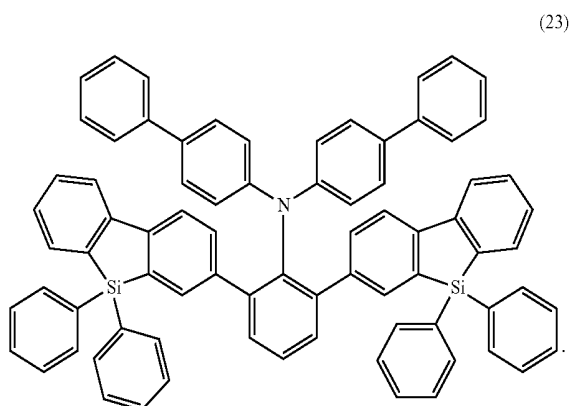
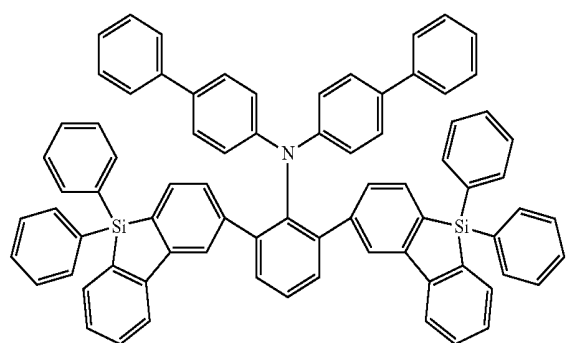
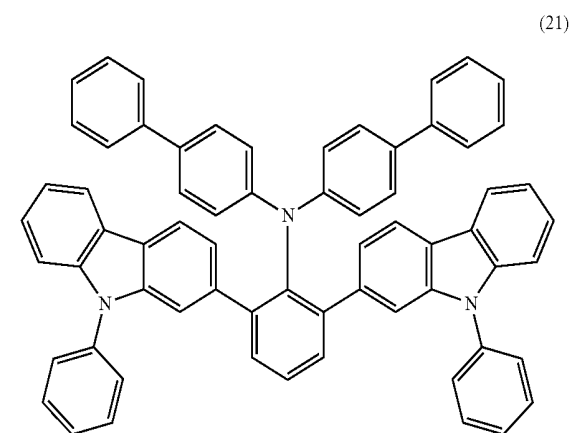
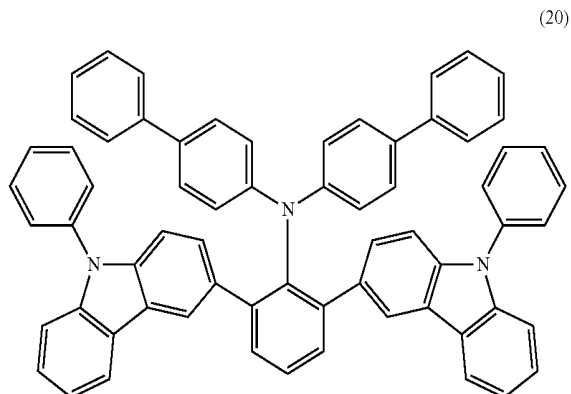

17. A method of preparing a triarylamine derivative represented by the following Formula 1, the method comprising:

preparing an amine derivative by reacting 1-amino-2,6-halogenated benzene and a dibenzoheterole derivative substituted with boronic acid; and

reacting the amine derivative with an unsubstituted aryl halide group having 6 to 30 carbon atoms for forming a ring or a substituted or unsubstituted heteroaryl halide group having 1 to 30 carbon atoms for forming a ring:

Formula 1

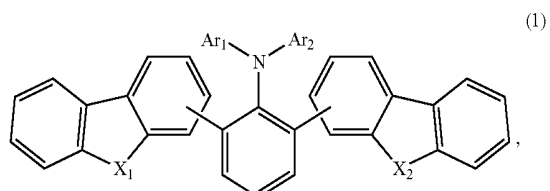

wherein Ar_1 and Ar_2 are each independently selected from a substituted or unsubstituted aryl group having 6 to 30 carbon atoms for forming a ring and a substituted or unsubstituted heteroaryl group having 1 to 30 carbon atoms for forming a ring, and

X_1 and X_2 are each independently selected from O, S, R_1-Si-R_2 , and $N-R_3$, and R_1 to R_3 are each independently selected from an alkyl group having 10 and less carbon atoms and an aryl group having 6 to 30 carbon atoms for forming a ring.

18. The method of preparing a triarylamine derivative of claim 17, wherein X_1 and X_2 are each independently selected from O and S.

19. The method of preparing a triarylamine derivative of claim 17, wherein the triarylamine derivative represented by Formula 1 is one selected from the compounds of Formula 2:

Formula 2

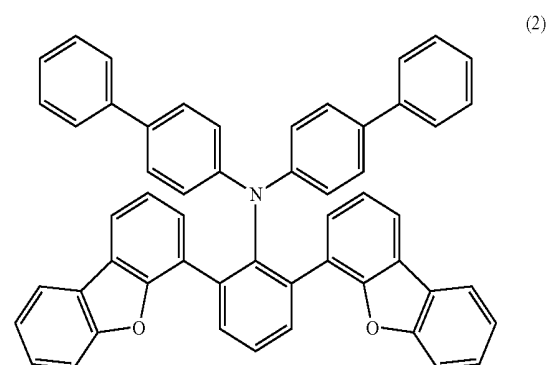

-continued

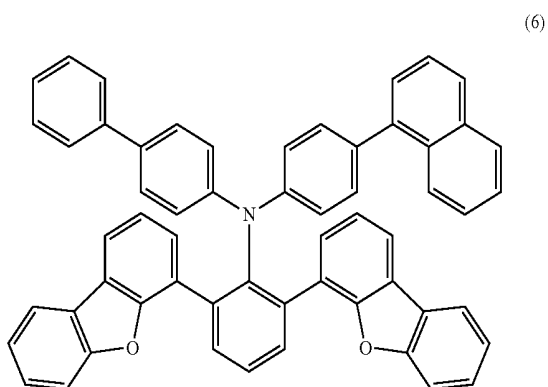
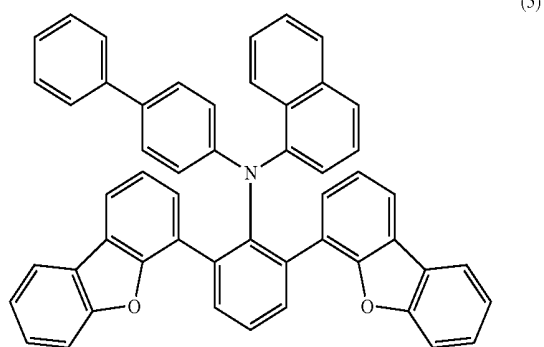
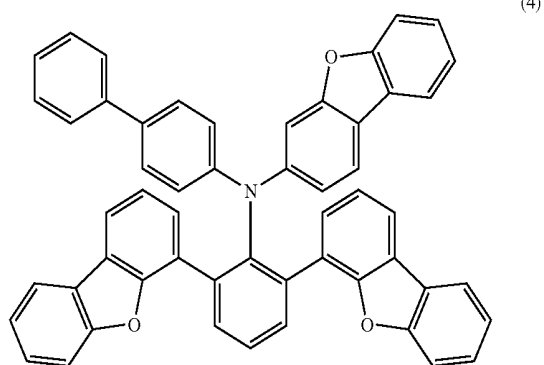
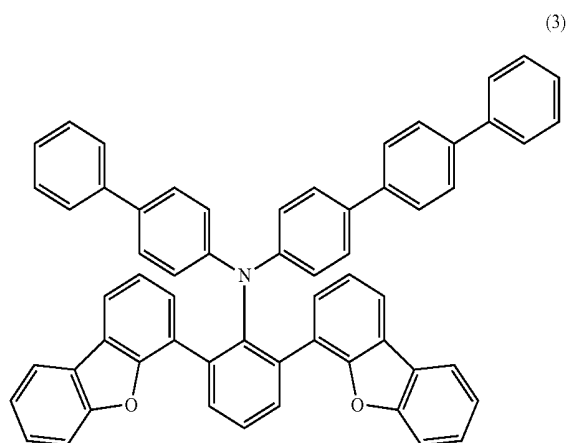

-continued

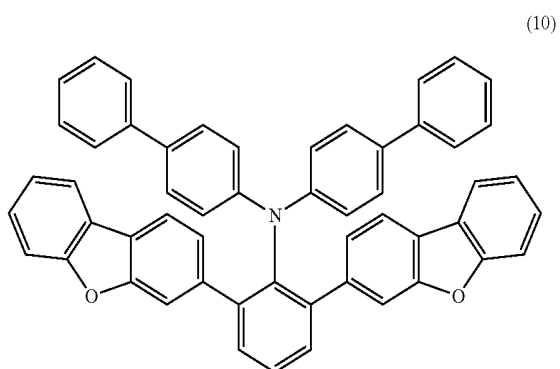
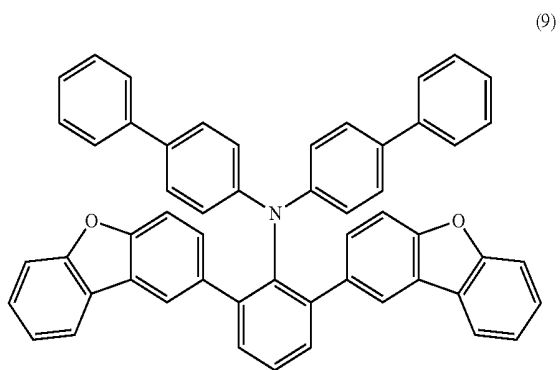
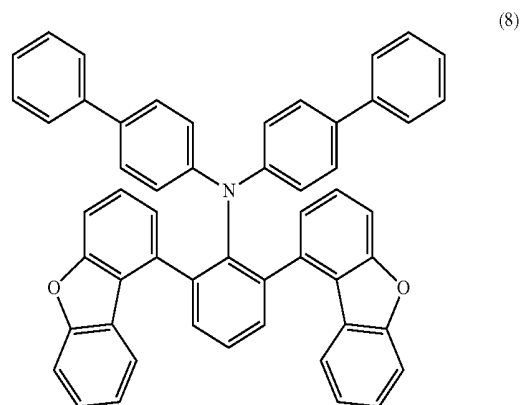
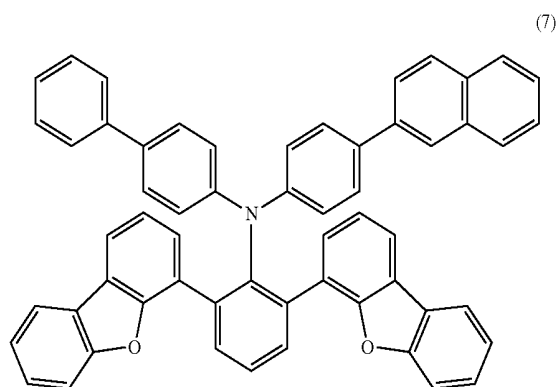

-continued

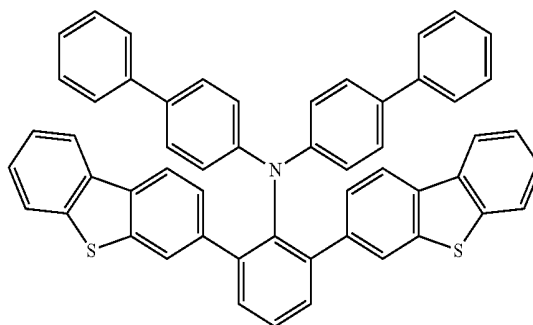
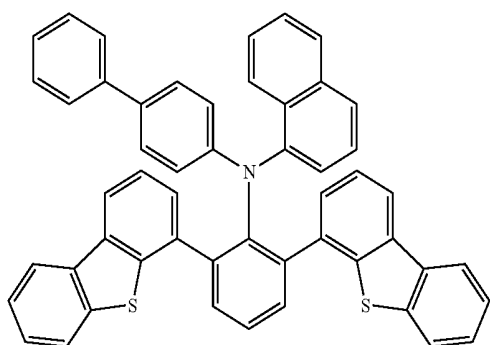
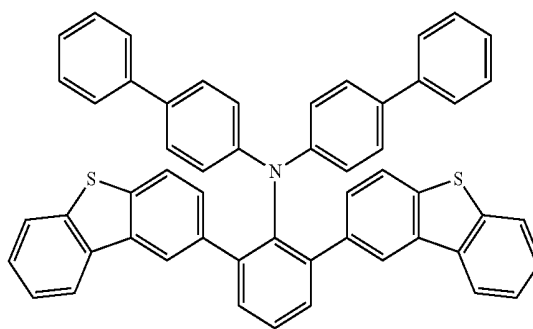
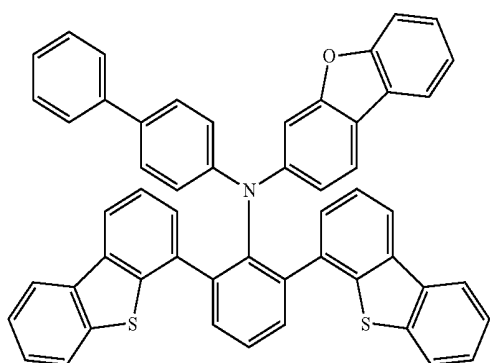
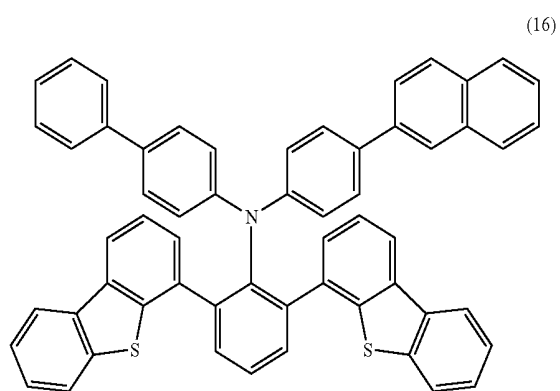
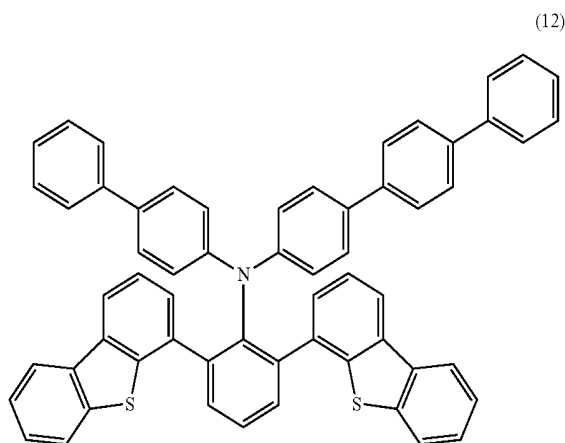
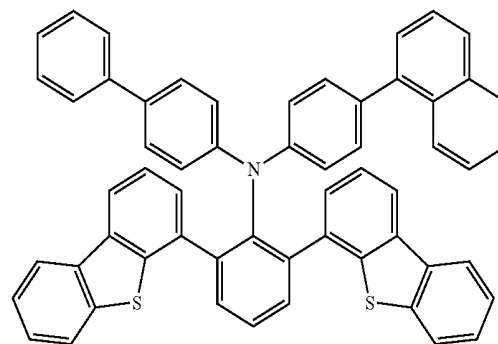
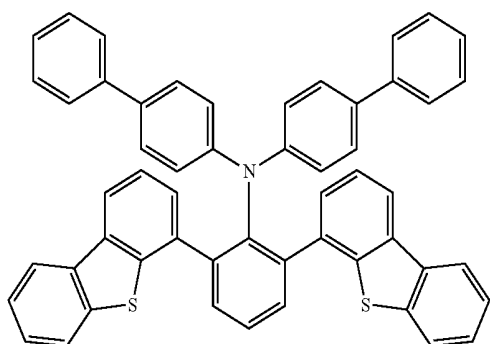

-continued

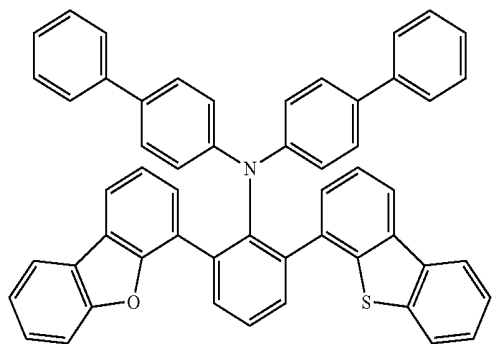

-continued

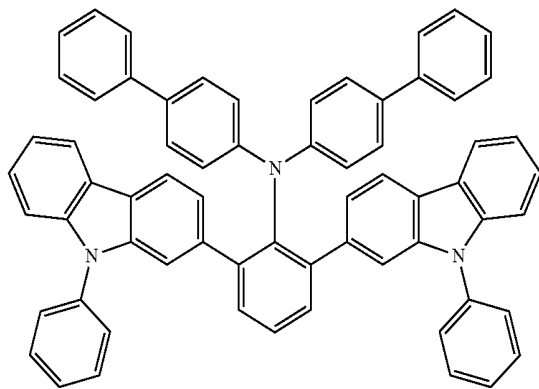

20. The material for an organic EL device of claim 17, wherein the triarylamine derivative represented by Formula 1 is one selected from the compounds of Formula 3:

Formula 3

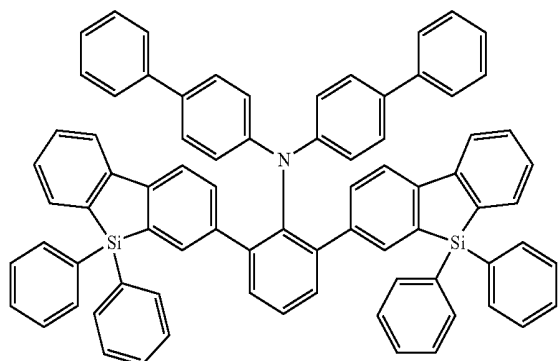
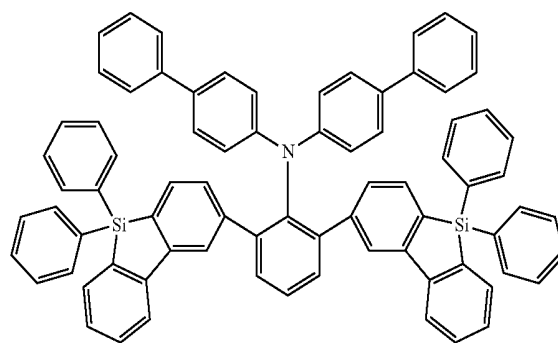
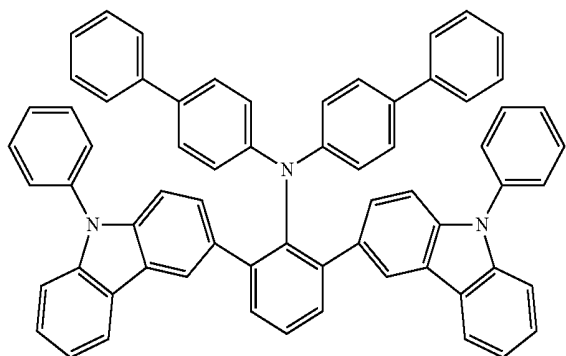

* * * * *

专利名称(译)	用于有机电致发光器件的材料，包括其的有机电致发光器件和三芳基胺衍生物的制备方法		
公开(公告)号	US20160315267A1	公开(公告)日	2016-10-27
申请号	US15/048505	申请日	2016-02-19
[标]申请(专利权)人(译)	三星显示有限公司		
申请(专利权)人(译)	三星DISPLAY CO. , LTD.		
当前申请(专利权)人(译)	三星DISPLAY CO. , LTD.		
[标]发明人	SAKAMOTO NAOYA		
发明人	SAKAMOTO, NAOYA		
IPC分类号	H01L51/00 C07D333/76 C07D409/10 C07D307/91		
CPC分类号	H01L51/0061 H01L51/006 C07D307/91 C07D333/76 H01L51/5056 H01L51/0073 H01L51/0052 H01L51/0074 C07D409/10 H01L51/0059		
优先权	2015086493 2015-04-21 JP		
其他公开文献	US10256413		
外部链接	Espacenet USPTO		

摘要(译)

本发明提供一种用于具有高发光效率的有机电致发光器件的材料和包括该材料的有机电致发光器件。根据本公开的用于有机电致发光器件的材料由式1表示：其中二苯并噻唑基团在相对于氮原子的邻位与三芳基胺的苯基偶联。由于二苯并噻唑基团的杂原子，分子的极性可能增加，并且由于胺基团周围的分子的大的空间变形，分子的能隙（例如，HOMO-LUMO间隙）可能增加。因此，可以在蓝色发光区域中提高有机EL器件的发光效率。

Formula 1

